



128 Kb Dual-Port SRAM with PCI Bus Controller (PCI-DP)

Features

- 128 Kb of dual-ported shared memory
- Master and Target PCI Specification 2.2 compliant interface
- Embedded host bridge capability
- Direct interface to many microprocessors
- I²O message transport unit; includes four 32-bit, 32-entry FIFO
- Local bus clock rates up to 50 MHz
- Single 3.3V Power Supply including compatibility with 3V and 5V PCI Bus signaling
- 160-pin thin plastic quad flat package

Introduction

The CY7C09449PV is one of the PCI interface controllers in the Cypress Semiconductor PCI-DP™ family. The CY7C09449PV provides a PCI master/target interface with direct connections to many popular microprocessors. It provides 128 Kb of dual-port SRAM that is used as shared memory between the local microprocessor and the PCI bus. An I²O message unit, complete with message queues and interrupt capability, is also provided. The CY7C09449PV allows the designer to interface an application to the PCI bus in a straightforward, inexpensive way.

Functional Overview

The CY7C09449PV is composed of a number of shared resources that allow effective data movement between the local bus and the PCI bus.

A primary resource within the CY7C09449PV is its 128 Kb of dual-port memory. This memory is interfaced to both the PCI bus and to a local microprocessor bus. This shared memory can be accessed as a target from both buses at the same time for inter-process communication. From either the local or PCI bus the CY7C09449PV can be directed to become a PCI bus master to move data into or out of the internal shared memory as a direct memory access (DMA). The CY7C09449PV can DMA across the PCI bus any number of 32-bit double words (DWORD), up to 16K bytes. It uses the full bursting capabilities of the PCI bus for maximum efficiency and can transfer data over the full 32-bit PCI address space.

The CY7C09449PV implements optional requirements of the PCI specification by selecting the optimum PCI command for each transaction it masters to the PCI bus. This maximizes overall efficiency of the system platform. PCI bridging functions (PCI-to-PCI and Host-to-PCI bridges) use the commands to enhance prefetch and cache coherency operations. The CY7C09449PV requests and gains access to the PCI bus as any master. It does not, within itself, include a PCI bus arbitration function. Standard PC PCI buses include this function; embedded systems may need to implement this function.

The CY7C09449PV provides a direct access mechanism from the local bus to the PCI bus. With it, the local processor can direct the CY7C09449PV to run a PCI bus master cycle of any kind to any address. This means that the CY7C09449PV can run PCI configuration cycles allowing it to be used as a host bridge.

Table of Contents

Features	1
Introduction	1
Functional Overview	1
Pin Configuration	4
Pin Description	5
PCI Bus	9
Local Bus	12
Timing Diagrams	16
I ² C Serial Port and Auto-Configuration	27
Operations Registers	29
Performance Characteristics	41
CY7C09449PV Operations	46
Ordering Information	48
Package Diagram	48

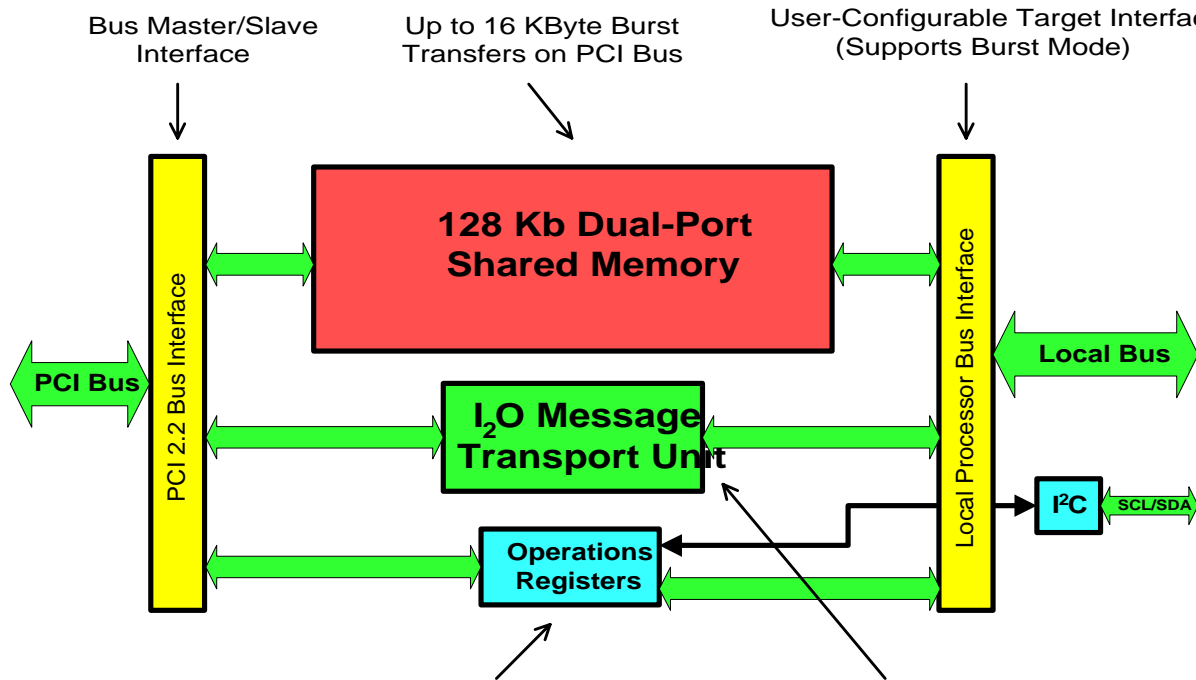

PCI-DP™ Allows Local Processor Provides Required FIFOs and Direct Access to PCI Bus Interrupt Status Registers

AN3042_BD.vs

Four First-In First-Out (FIFO) storage elements provide another resource to the user. These are accessible from either the PCI bus or the Local bus. When the I₂O messaging unit functionality of the CY7C09449PV is to be used, the four FIFOs become part of the I₂O messaging unit of the CY7C09449PV. The I₂O messaging unit consists of the four FIFOs and the I₂O system interrupt registers. The shared memory of the CY7C09449PV may be used to store I₂O message frame buffers while most of shared memory is still available for general purpose use. Efficient I₂O messaging is realized when the local processor uses the CY7C09449PV direct access mechanism. It can be used to retrieve and post I₂O message pointers to other I₂O agents. Data transfer of the messages themselves is made very efficient using the CY7C09449PV PCI DMA controller to burst the message frames to other I₂O agents.

Interprocess communication is supported by two resources of the CY7C09449PV: the mailbox registers and the arbitration flags. By writing to the mailbox registers, a method is available for the local processor to pass data while causing an interrupt to the host, and vice versa. This is enabled by the interrupt mask located in the CY7C09449PV Operations Registers. The arbitration flags are four pairs of bits that can be used to manage resource allocation and sharing between software and system processes.

The CY7C09449PV includes an interrupt controller. There are separate interrupt mask and command/status registers for the

PCI bus and the Local bus. The interrupt sources are DMA completion, mailbox, FIFO not empty (also for I₂O), FIFO overflow, PCI master abort, PCI target abort, and there is an external interrupt input pin. This interrupt controller is used to signal interrupts onto the PCI bus and the Local bus. The CY7C09449PV interrupt controller does not perform the interrupt controller function for the PCI bus system. Standard PC PCI systems include this function; embedded systems may need to implement this function.

An I²C-compatible serial interface is provided to allow the use of a serial EEPROM for non-volatile storage of CY7C09449PV initialization parameters. The parameters are PCI configuration and local bus settings. The CY7C09449PV will optionally access the EEPROM after reset and download initialization information before responding to PCI or local bus transactions. A wide variety of available I²C-compatible serial components are available to the local and host processor when connected through this interface.

The CY7C09449PV local bus is a flexible, configurable interface that is designed to readily connect to many industry standard microprocessors. In most cases, no external interface logic ("glue") is needed.

The following block diagram illustrates a generic application for the CY7C09449PV.

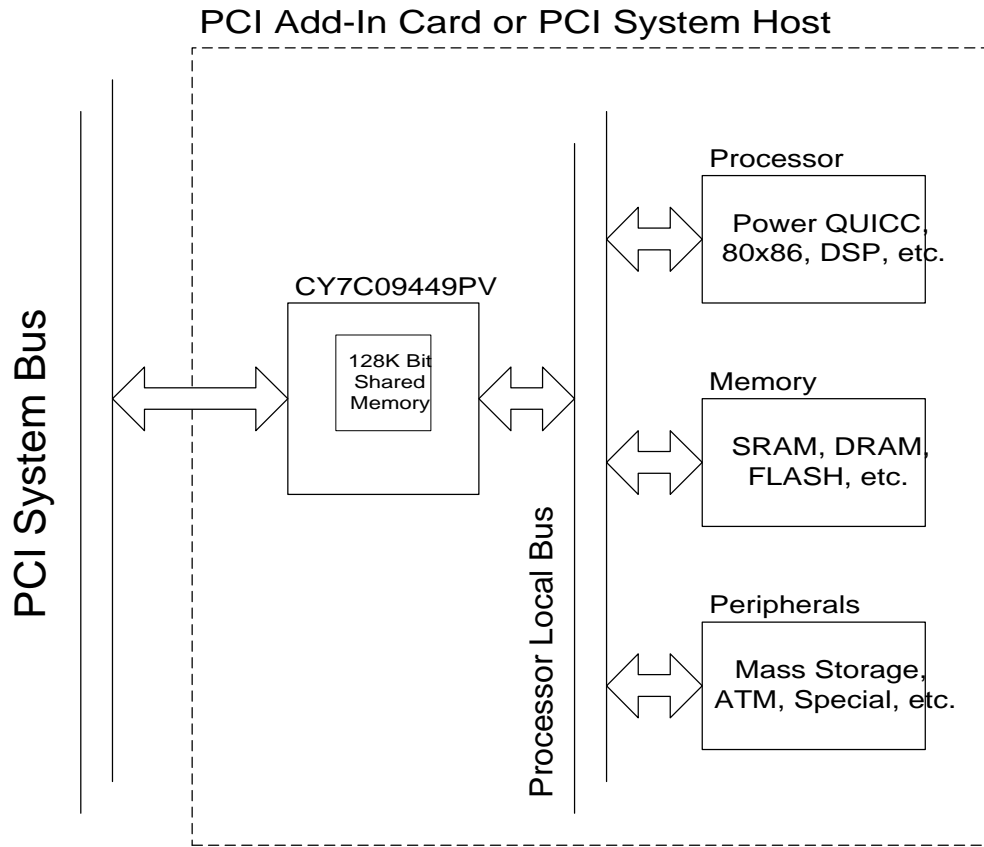

3042APP.VSD DB 6/02

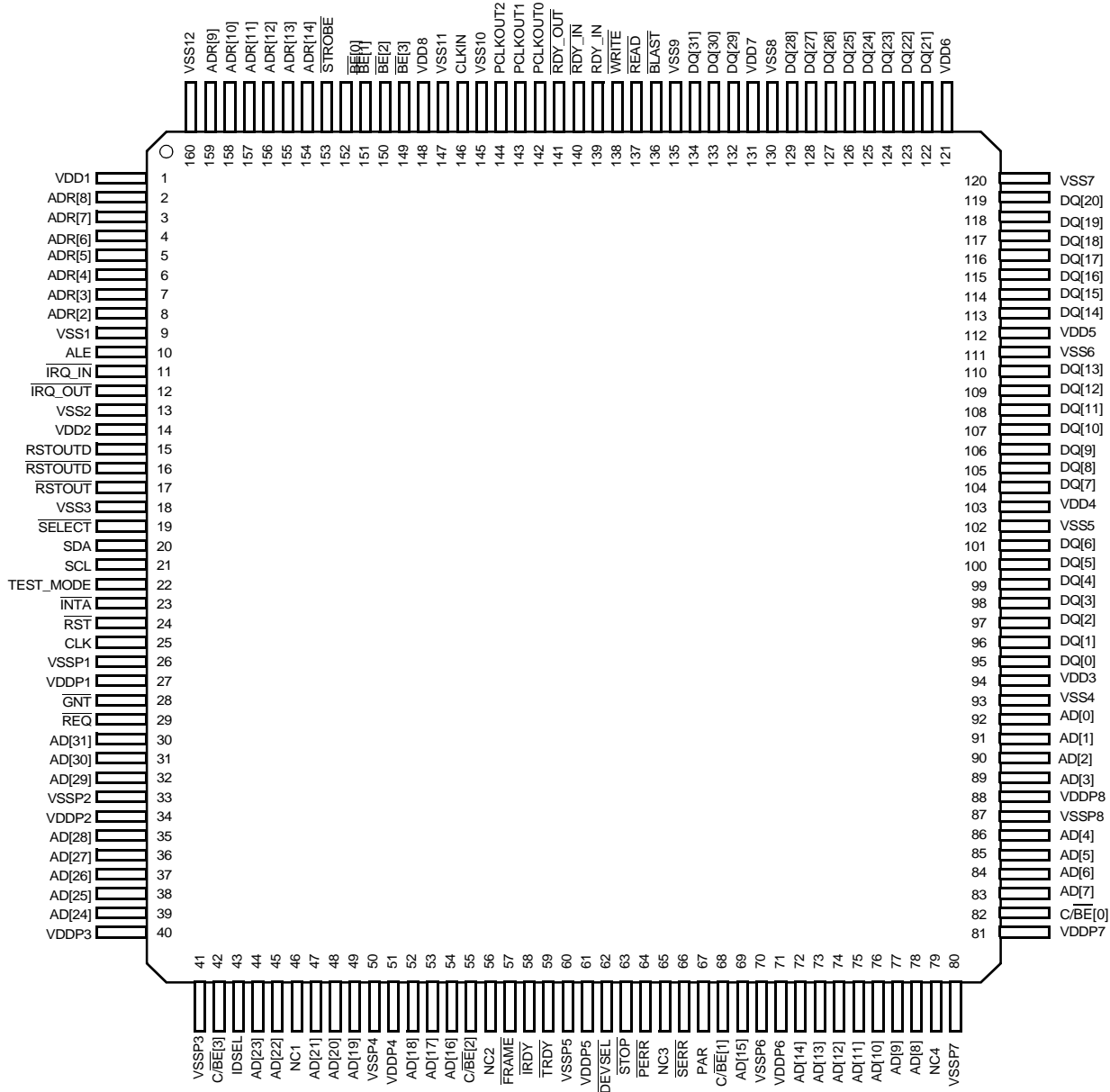
Pin Configuration
**160-Lead TQFP (A160)
for CY7C09449PV
Top View**

Pin Description

The Pin Type for CY7C09449PV is defined as follows:

in	Input is a standard input-only signal.
out	Standard output driver.
t/s	Three-state is an output or bidirectional signal.
s/t/s	Sustained Three-State is an active LOW, three-state capable signal driven by only one bus agent at a time. When ownership is passed to another agent, the signal is driven HIGH for one clock, and then three-stated for an additional clock before being driven by the new owner.
o/d	Open Drain signals allow multiple devices to share the pin as a wired-OR.
o/c	Open Collector signals allow multiple devices to share the pin as a wired-OR.

PCI Bus Signals

Signal Name	Type	Description
CLK	in	Clock: This is the PCI Bus clock and is the timing reference for all PCI bus transactions. The CY7C09449PV can operate with a 33-MHz PCI bus interface.
RST	in	RESET: This signal is the PCI bus reset. It is one of the few PCI signals which may be asserted or deasserted asynchronously to the PCI bus clock (CLK).
AD[31:0]	t/s	Address and Data: These signals represent the PCI bus address and data signals multiplexed on the same PCI pins. Information on these pins is identified as an <u>address</u> during the clock cycle in which the signal FRAME is first asserted. This is termed the "address phase" of a bus transaction. Information on these pins represents valid read or write data when both IRDY and TRDY are asserted, based on the current cycle type as defined on the C/BE lines during the address phase. This condition is termed the "data phase" of a bus transaction.
C/BE[3:0]	t/s	Command and Byte Enables: These pins are used with the AD[31:0] pins. During the address phase of a bus operation, they identify the bus command to be performed. During the data phase of a bus operation they identify which bytes are involved.
PAR	t/s	Parity: This PCI bus pin represents the even parity across the A/D[31:00] and C/BE[3:0] pins (36 pins) and is generated with a one clock delay.
FRAME	s/t/s	Cycle Frame: This PCI bus pin is asserted by the current bus master to signify the beginning of a bus transaction. Data transfers may continue in burst mode while FRAME remains asserted. When FRAME is deasserted it indicates that the transaction is in the final data phase.
IRDY	s/t/s	Initiator Ready: This signal is driven by the current bus master (initiator) and asserted to indicate its ability to complete the current data phase. Data is transferred when both IRDY and TRDY are asserted, otherwise wait cycles will occur.
TRDY	s/t/s	Target Ready: This signal is driven by the selected bus target and asserted when that target is ready to complete the current data phase. Data is transferred when both IRDY and TRDY are asserted, otherwise wait cycles will occur.
STOP	s/t/s	Stop: The STOP signal is driven by the selected bus target and is asserted when it wishes to cease the current data transaction.
IDSEL	in	Initialization Device Select: This signal is used to gain access to the PCI configuration register space of a given PCI Bus agent.
DEVSEL	s/t/s	Device Select: The DEVSEL signal is driven and asserted by the currently selected PCI bus target based on the current address and that target's assigned address range. Bus masters examine this signal to determine whether the desired device is present.

PCI Bus Signals (continued)

Signal Name	Type	Description
REQ	t/s	Request: This signal indicates to the bus arbiter that this device wishes to use the bus. It is a point-to-point signal that is driven whenever RST is not asserted.
GNT	t/s	Grant: This point-to-point signal indicates that the bus has been granted to the requester. It is driven whenever RST is not asserted and is ignored during the assertion of RST.
PERR	s/t/s	Parity Error: This signal indicates that a parity error has occurred. It is driven by the target or master that is the receiver of data at the clock after the PAR signal becomes valid.
SERR	o/d	System Error: This open drain signal is driven by any device that detects odd parity during an address phase.
INTA	o/d	Interrupt A: This signal is asserted when interrupt servicing of the CY7C09449PV device is required. The INTA pin is a shared PCI bus signal and utilizes an open-drain element to allow a wired-OR.

Local Bus Interface Signals

Signal Name	Type	Description
ADR[14:2]	in	Address: These signals identify the local memory location. When the local processor outputs multiplexed address and data, those lines need to be tied to both the DQ[14:2] and ADR[14:2].
BE[3:0]	in	Byte Enables: The Byte Enable inputs identify the specific bytes involved in an access. The pins may be configured as byte lane enables, directly, or used as size and encoded byte lane enables when interfacing to certain Motorola processors; see the Local Bus section for definition.
DQ[31:0]	t/s	Data: CY7C09449PV data input and output are provided on these bidirectional pins. This bus remains in high impedance during power-up and active Reset (RST) and only drives during read transactions.
SELECT	in	Chip Select: This signal must be asserted for the full duration of any access. The polarity is programmable; the default is active LOW.
ALE	in	Address Latch Enable: The local address provided on ADR[14:2] is latched on the trailing edge (from active to inactive) of this signal. The polarity is programmable; the default is active HIGH.
STROBE	in	Address Strobe: The assertion of this signal begins a memory access and indicates that a valid address has been latched through ALE or is provided at the pins (if ALE is not used and is tied active). The address is provided on the ADR[14:2] pins (during non-multiplexed mode), or on the DQ[14:2] (during multiplexed mode). Outside the address phase, the level of STROBE is don't care. The polarity is programmable; the default is active LOW.
WRITE READ	in	Write and Read Signals: These signals control the transfer of data to and from the local data bus. WRITE and READ are sampled in the address phase and are don't cares during the remainder of the bus transaction. The polarity and function of these signals is programmable so that they can be interfaced to processors that support WR/RD or RD/WR, as well as separate RD/RD and WR/WR signals.
BLAST	in	Burst Last: The signal indicates the end of a burst transfer. This signal has two modes. It can be active during the burst and go inactive when the burst is over, or it can go active during the last data phase of the burst. The polarity is programmable; the default is active LOW.
RDY_IN RDY_IN	in	Ready In: The assertion of these signals indicates that the local processor is prepared to complete the current data transaction.
RDY_OUT	out or t/s	Ready Out: When this signal is asserted it indicates that the CY7C09449PV is ready to complete the current access. The polarity is programmable; the default is active LOW. This signal is also programmable to three-state when inactive; the default is to three-state when inactive.

Local System Signals

Signal Name	Type	Description
PCLKOUT2 PCLKOUT1 PCLKOUT0	out	Clock Outputs: These pins provide three buffered copies of the PCI bus clock.
CLKIN	in	Clock In: This pin provides the timing reference for local bus signals. The CLKIN pin can be driven by an external clock. Also, one of the buffered copies of the PCI clock, PCLKOUT[2:0], may be used as input to CLKIN. This clock must be toggling for proper start-up operation of the CY7C09449PV as well as for PCI access to resources other than the dual-ported shared memory.
RSTOUT	out	Reset Out: This pin provides a buffered version of the PCI bus signal, $\overline{\text{RST}}$.
RSTOUTD RSTOUTD	out	Reset Out Delayed: These pins are similar to the $\overline{\text{RSTOUT}}$ pin described above, however RSTOUTD and RSTOUTD remain asserted until released by the host interface via software control. This allows the CY7C09449PV to hold the local processor in reset until the host processor is ready to release it.
IRQ_OUT	t/s	Interrupt Request Out: This signal may be used to trigger an interrupt on the local microprocessor. A variety of host-triggered events can be used to cause the assertion of this interrupt request output. This signal may be masked using the Local Interrupt Control/Status Register. When in the inactive state, this signal is three-stated. The polarity is programmable; the default is active LOW.
IRQ_IN	in	Interrupt Request In: This signal, when asserted, will result in the CY7C09449PV driving the PCI bus INTA signal and therefore cause an interrupt of the host system. This signal may be masked using the Host Interrupt Control/Status Register.
TEST_MODE	in	Test Mode: When HIGH, this pin puts the CY7C09449PV into a factory test mode. When HIGH and READ is LOW, all outputs are set to high impedance except RDY_OUT will continue to drive if Operations Register LBUSCFG bit 16 is '0'. This is the only test mode available to the user. The user must drive this signal LOW if unused.

Local Configuration Signals

Signal Name	Type	Description
SCL	o/c	Serial Clock: This pin is the clock output to be used with an external I ² C-compatible serial memory device. A pull-up resistor is required.
SDA	o/c	Serial Data: This pin is the bidirectional data pin to be used with an external I ² C-compatible serial memory device. A pull-up resistor is required.

Power Pins

Signal Name	Type	Description
VSSP1–VSSP8, VSS1–VSS12	GND	Ground: These pins are ground pins (0 volts).
VDDP1–VDDP8, VDD1–VDD8	POWER	Power: These pins provide power, nominally 3.3 volts.

Other Pins

Signal Name	Type	Description
NC1–NC4	NC	No Connect: These pins are not to be used; leave unconnected.

Signal Terminations

PCI Bus signals should be terminated according to the PCI 2.2 specification. Generally, termination is provided by the PCI system. If the CY7C09449PV is used as a PCI add-in card or other device as part of a PCI bus, no termination should be used. For embedded systems, then terminations are part of the system design; they are not particular to the CY7C09449PV. Any PCI system must include a single pull-up on each PCI bus control signal used. These signals are FRAME, TRDY, IRDY, DEVSEL, STOP, SERR, PERR, LOCK, INTA, INTB, INTC, INTD, REQ64, and ACK64. Refer to Sec-

tion 4.3, System (Motherboard) Specification, of the PCI 2.2 specification for detailed requirements.

All Local System and Local Bus Interface input signals must be driven at all times. If they are unused inputs, then they may be driven either HIGH or LOW (pull-up or pull-down, V_{DD} or Ground).

SCL and SDA must have a pull-up in the range of 2.2 kΩ to 10 kΩ to V_{DD}. These pull-ups are required whether the signals are to be used or not.

Pin List

Pin Name	No.	Pin Name	No.	Pin Name	No.	Pin Name	No.
VDD1	1	VSSP3	41	VDDP7	81	VDD6	121
ADR[8]	2	C/BE[3]	42	C/BE[0]	82	DQ[21]	122
ADR[7]	3	IDSEL	43	AD[7]	83	DQ[22]	123
ADR[6]	4	AD[23]	44	AD[6]	84	DQ[23]	124
ADR[5]	5	AD[22]	45	AD[5]	85	DQ[24]	125
ADR[4]	6	NC1	46	AD[4]	86	DQ[25]	126
ADR[3]	7	AD[21]	47	VSSP8	87	DQ[26]	127
ADR[2]	8	AD[20]	48	VDDP8	88	DQ[27]	128
VSS1	9	AD[19]	49	AD[3]	89	DQ[28]	129
ALE	10	VSSP4	50	AD[2]	90	VSS8	130
IRQ_IN	11	VDDP4	51	AD[1]	91	VDD7	131
IRQ_OUT	12	AD[18]	52	AD[0]	92	DQ[29]	132
VSS2	13	AD[17]	53	VSS4	93	DQ[30]	133
VDD2	14	AD[16]	54	VDD3	94	DQ[31]	134
RSTOUTD	15	C/BE[2]	55	DQ[0]	95	VSS9	135
RSTOUTD	16	NC2	56	DQ[1]	96	BLAST	136
RSTOUT	17	FRAME	57	DQ[2]	97	READ	137
VSS3	18	IRDY	58	DQ[3]	98	WRITE	138
SELECT	19	TRDY	59	DQ[4]	99	RDY_IN	139
SDA	20	VSSP5	60	DQ[5]	100	RDY_IN	140
SCL	21	VDDP5	61	DQ[6]	101	RDY_OUT	141
TEST_MODE	22	DEVSEL	62	VSS5	102	PCLKOUT0	142
INTA	23	STOP	63	VDD4	103	PCLKOUT1	143
RST	24	PERR	64	DQ[7]	104	PCLKOUT2	144
CLK	25	NC3	65	DQ[8]	105	VSS10	145
VSSP1	26	SERR	66	DQ[9]	106	CLKIN	146
VDDP1	27	PAR	67	DQ[10]	107	VSS11	147
GNT	28	C/BE[1]	68	DQ[11]	108	VDD8	148
REQ	29	AD[15]	69	DQ[12]	109	BE[3]	149
AD[31]	30	VSSP6	70	DQ[13]	110	BE[2]	150
AD[30]	31	VDDP6	71	VSS6	111	BE[1]	151
AD[29]	32	AD[14]	72	VDD5	112	BE[0]	152
VSSP2	33	AD[13]	73	DQ[14]	113	STROBE	153
VDDP2	34	AD[12]	74	DQ[15]	114	ADR[14]	154
AD[28]	35	AD[11]	75	DQ[16]	115	ADR[13]	155
AD[27]	36	AD[10]	76	DQ[17]	116	ADR[12]	156
AD[26]	37	AD[9]	77	DQ[18]	117	ADR[11]	157
AD[25]	38	AD[8]	78	DQ[19]	118	ADR[10]	158
AD[24]	39	NC4	79	DQ[20]	119	ADR[9]	159
VDDP3	40	VSSP7	80	VSS7	120	VSS12	160

Memory Map

CY7C09449PV resources are accessed from the PCI bus as an offset from Base Address Register 0 (BAR 0), unless otherwise indicated. Resources are also accessed from the Local bus when the SELECT pin is active. PCI I/O access to this memory map is also available via PCI I/O pointers located at Base Address Register 1 (BAR 1). The memory map covers a continuous 32KB address space.

Memory Contents	Address [14:0], Byte Offset	Size
I ₂ O Specific Registers	0x0000 - 0x03FF	1 KB
Operations Registers	0x0400 - 0x07FF	1 KB
reserved	0x0800 - 0x1FFF	6 KB
Direct Access to PCI Bus (this is a window into PCI space; this window is only available to the Local bus)	0x2000 - 0x3FFF	8 KB
Shared Memory	0x4000 - 0x7FFF	16 KB

PCI Bus

The PCI bus of the CY7C09449PV operates per the PCI Specification revision 2.2. This section describes the specific PCI functions supported by the CY7C09449PV. Reference URL: <http://www.pcisig.com/>

PCI Configuration Space

PCI Configuration Space				
31	16	15	0	Address, Byte Offset
Device ID, <i>RO</i>		Vendor ID, <i>RO</i>		0x00
Status, <i>CS</i>		Command, <i>CS</i>		0x04
Class Code, <i>RO</i>			Revision ID, <i>RO</i>	0x08
BIST (not used) 24 0x00	Header Type 0x00	Latency Timer, 8 <i>RW</i>	Cache Line Size, <i>RW</i>	0x0C
Base Address Register #0 -- 32KBytes Memory Space, <i>RW</i>				0x10
Base Address Register #1 -- 8 Bytes I/O Space, <i>RW</i>				0x14
Base Address Register #2 (not used) 0x0000				0x18
Base Address Register #3 (not used) 0x0000				0x1C
Base Address Register #4 (not used) 0x0000				0x20
Base Address Register #5 (not used) 0x0000				0x24
Cardbus CIS Pointer, <i>RO</i>				0x28
Subsystem Device ID, <i>RO</i>		Subsystem Vendor ID, <i>RO</i>		0x2C
Expansion ROM Base Address (not used) 0x0000				0x30
Reserved 0x0000				0x34
Reserved 0x0000				0x38
MAX_LAT, <i>RO</i>	MIN_GNT, <i>RO</i>	Interrupt Pin, <i>RO</i>	Interrupt Line, <i>RW</i>	0x3C

Legend for PCI Configuration Space Table

0x00 or 0x0000	Hardwired to zero
<i>RO</i>	Read-only: may be initialized by EEPROM across I ² C-compatible serial interface
<i>CS</i>	Control and status register
<i>RW</i>	Read/write

Vendor ID

Address: 0x01 - 0x00

Default Value: 0x12BE

Read-only: Can be initialized from the external memory accessed via the I²C-compatible serial interface

This 2-byte register contains the Vendor ID assigned by the PCI SIG. The default value is the Cypress Semiconductor Vendor ID. Using the I²C-compatible serial interface for initialization provides a method to allow a manufacturer to load their own vendor ID.

Device ID

Address: 0x03 - 0x02

Default Value: 0x3042

Read-only: Can be initialized from the external memory accessed via the I²C-compatible serial interface

This 2-byte register contains the device ID assigned by the manufacturer. The default value is the CY7C09449PV chip device ID. Using the I²C-compatible serial interface for initialization provides a method to allow a manufacturer to load their own device ID.

Command

Address: 0x05 - 0x04

Default Value: 0x0000

Read/Write

This 2-byte register contains bits for device control. These bits are normally set by the system BIOS. The following bits are supported:

Bit 0: Enable response to I/O space accesses.

Bit 1: Enable response to Memory space accesses.

Bit 2: Enable PCI bus master operation (may be initialized over the I²C-compatible serial interface).

Bit 3: Enable special cycle monitoring, (but CY7C09449PV performs no special function as a target).

Bit 4: Enable bus master use of the Memory Write and Invalidate command.

Bit 6: Enable the $\overline{\text{PERR}}$ signal for host notification of data parity errors.

Bit 8: Enable the $\overline{\text{SERR}}$ signal for host notification of system errors.

Bit 9: Enable fast back-to-back transactions to different agents (but CY7C09449PV does not generate).

Status

Address: 0x07 - 0x06

Default Value: 0x0280

Read-only and Write-1-to-Clear except as indicated.

This 2-byte register contains bits for device status. The following bits are supported:

Bit 7: Read-only bit set to indicate, as a target, the chip can accept fast back-to-back transactions.

Bit 8: Set when $\overline{\text{PERR}}$ is asserted.

Bits 10 and 9: Read-only bits set to 0x1 indicating medium response timing for $\overline{\text{DEVSEL}}$.

Bit 12: Set when, as a master, the chip's transaction has been terminated with Target-Abort.

Bit 13: Set when, as a master, the chip terminates a transaction with Master-Abort.

Bit 14: Set when $\overline{\text{SERR}}$ is asserted.

Bit 15: Set whenever a parity error is detected.

Revision ID

Address: 0x08

Default Value: 0x02

Read-only: Can be initialized from the external memory accessed via the I²C-compatible serial interface.

This 1-byte register contains the Revision ID assigned by the manufacturer. The default value is set by Cypress Semiconductor at manufacturing time. Using the I²C-compatible serial interface for initialization provides a method to allow a manufacturer to load their own Revision ID.

Class Code

Address: 0x0B - 0x09

Default Value: 0x0E0001

Read-only: Can be initialized from the external memory accessed via the I²C-compatible serial interface.

This 3-byte register contains the class code assigned by the manufacturer. The default value indicates an I²O base class (0x0E), a sub-class of 0x00, and the programming interface that supports system interrupt capability (0x01). Using the I²C-compatible serial interface for initialization provides a method to allow a manufacturer to load their own class code.

Cache Line Size

Address: 0x0C

Default Value: 0x00

Read/Write

This register contains the cache line size in DWORDs. The only valid size is 0x08; any other value written will result in a 0x00 being written to the register. The value in this register is used to control when the master can perform Memory Write and Invalidate cycles. Additionally, the type of memory read command is determined by this value; (i.e., Memory Read, Memory Read Line, or Memory Read Multiple).

Latency Timer

Address: 0x0D

Default Value: 0x00

Read/Write

This register controls how quickly the master must get off the bus if GNT is removed. The CY7C09449PV implements bits [7:3] of this register, providing a granularity of eight clocks.

Base Address Register 0 (Memory Type Access)

Address: 0x13 - 0x10

Default Value: 0x00000000

Read all 32 bits, Write bits [31–15]

This register provides the base address of the CY7C09449PV memory map. Bits [31–15] are read/write, indicating to the system BIOS that the shared memory space is 32 K bytes. If a PCI memory transaction has address bits [31–15] matching the contents of this register and memory accesses are enabled (by Command register bit 1), then the CY7C09449PV chip will acknowledge and accept the transfer.

Base Address Register 1 (I/O Type Access)

Address: 0x17 - 0x14

Default Value: 0x00000001

Read all 32 bits, Write bits [31–3]

This register provides the base address of the CY7C09449PV I/O pointer space. Bits [31–3] are read/write, indicating to the system BIOS that the I/O pointer space is 8 bytes. If a PCI I/O transaction has address bits [31–3] matching the contents of this and I/O accesses are enabled (by Command register bit 0), then the CY7C09449PV will acknowledge and accept the transfer.

Cardbus CIS Pointer

Address - 0x2B - 0x28

Default Value: 0x00000000

Read-only: Can be initialized from the external memory accessed via the I²C-compatible serial interface.

This register contains the Cardbus Card Information Structure (CIS). Using the I²C-compatible serial interface for initialization provides a method to allow a manufacturer to load their own CIS pointer value.

Subsystem Vendor ID

Address: 0x2D - 0x2C

Default Value: 0x0000

Read-only: Can be initialized from the external memory accessed via the I²C-compatible serial interface.

This 2-byte register contains the subsystem vendor ID chosen by the manufacturer. Using the I²C-compatible serial interface for initialization provides a method to allow a manufacturer to load their own subsystem vendor ID.

Subsystem Device ID

Address: 0x2F - 0x2E

Default Value: 0x0000

Read-only: Can be initialized from the external memory accessed via the I²C-compatible serial interface.

This 2-byte register contains the subsystem device ID chosen by the manufacturer. Using the I²C-compatible serial interface for initialization provides a method to allow a manufacturer to load their own subsystem device ID.

Interrupt Line

Address: 0x3C

Default Value: 0x00

Read/Write

This single-byte register contains the interrupt line routing.

Interrupt Pin

Address: 0x3D

Default Value: 0x00

Read-only: Can be initialized from the external memory accessed via the I²C-compatible serial interface.

This single-byte register contains the interrupt pin information. The default value indicates that the CY7C09449PV chip is not connected to the interrupts on the PCI bus. Using the I²C-compatible serial interface for initialization provides a method to allow a manufacturer to specify which interrupt pin is on the bus. Only bits [2–0] are implemented. All four Interrupt numbers are supported, (INTA through INTD).

MIN_GNT

Address: 0x3E

Default Value: 0x00

Read-only: Can be initialized from the external memory accessed via the I²C-compatible serial interface.

This single-byte register contains the minimum grant time in 1/4 microsecond increments needed for efficient operation. The default value indicates the add-in card has no major requirements for the setting of the latency timer. The latency timer governs how long a burst transaction may use the PCI bus. Whatever the value, the CY7C09449PV itself does not use the MIN_GNT data. It is used as a means to communicate system requirements to the host. Using the I²C-compatible serial interface for initialization provides a method to allow a manufacturer to load their own minimum grant time reflective of their add-in card requirements.

MAX_LAT

Address: 0x3F

Default Value: 0x00

Read-only: Can be initialized from the external memory accessed via the I²C-compatible serial interface.

This single-byte register contains the minimum latency time in 1/4 microsecond increments needed for efficient operation. The default value indicates the add-in card has no major requirements for how soon it needs access to the PCI bus once it has requested an access. Whatever the value, the CY7C09449PV itself does not use MAX_LAT data. It is used as a means to communicate system requirements to the host. Using the I²C-compatible serial interface for initialization provides a method to allow a manufacturer to load their own minimum latency time reflective of their add-in card requirements.

PCI Bus Commands

All Memory and I/O commands are supported as target and master.

- I/O Read $\overline{C/BE}[3:0] = 0x2$
- I/O Write $\overline{C/BE}[3:0] = 0x3$
- Memory Read $\overline{C/BE}[3:0] = 0x6$
- Memory Write $\overline{C/BE}[3:0] = 0x7$
- Memory Read Multiple $\overline{C/BE}[3:0] = 0x8$
- Memory Read Line $\overline{C/BE}[3:0] = 0xE$
- Memory Write and Invalidate $\overline{C/BE}[3:0] = 0xF$

All Configuration commands are supported as target and master. Additionally, the CY7C09449PV can perform these ac-

cesses on its own PCI Configuration space. Control originates from the Local bus using the CY7C09449PV Direct Access feature. This is a necessary feature for the CY7C09449PV to perform as a Host Bridge device. Type 0 and Type 1 PCI configuration commands may be generated by the CY7C09449PV. For details, see the Direct Access and Host Bridge descriptions in the CY7C09449PV Operations section.

- Configuration Read $C/\overline{BE}[3:0] = 0xA$
- Configuration Write $C/\overline{BE}[3:0] = 0xB$

Interrupt Acknowledge and Special Cycle are supported on master cycles. As a target, no action is performed by the CY7C09449PV.

- Interrupt Acknowledge $C/\overline{BE}[3:0] = 0x0$
- Special Cycle $C/\overline{BE}[3:0] = 0x1$

The following command is not supported, a target access will result in no response by the CY7C09449PV as per the PCI specification.

- Dual-Address Cycle $C/\overline{BE}[3:0] = 0xD$

The following commands are PCI Reserved and are not responded to as per PCI specification.

- Reserved $C/\overline{BE}[3:0] = 0x4$
- Reserved $C/\overline{BE}[3:0] = 0x5$
- Reserved $C/\overline{BE}[3:0] = 0x8$
- Reserved $C/\overline{BE}[3:0] = 0x9$

PCI I/O Pointers

Utilization of PCI I/O access is not generally recommended by the PCI special interest group. New system designs should use the PCI Memory access rather than PCI I/O access. In general, this is provided as a support to legacy systems. The CY7C09449PV Base Address Register 1 (BAR1) is the offset reference for PCI I/O access to this device.

I/O Address Pointer

Address: 0x1 - 0x0

Default Value: unknown, not initialized

Write-only

The value written to this location is the offset into the CY7C09449PV Memory Map. Bit 15 is "don't care."

I/O Data Pointer

Address: 0x7 - 0x4

Default Value: unknown, not initialized

Read/Write

Upon a write to the pointer, the data shall be written to the location in the CY7C09449PV Memory Map specified by the contents of the I/O address pointer. If an I/O read access to the pointer, then the data at the location in the CY7C09449PV Memory Map which is specified by the contents of the I/O address pointer shall be returned.

Local Bus

General Description

The CY7C09449PV provides a configurable local processor bus interface which can provide direct connection to several processor types. The interface is synchronous to the CLKIN signal. The CLKIN signal can be tied to the local processor's

clock, a derivative, or an independent clock source. To run the local interface at PCI clock speeds, any one of the PCLKOUT[2:0] pins should be connected to CLKIN.

The basic local processor bus transaction consists of an address phase, followed by one or more data phases. The interface signals are generally divided into those signals that qualify the address phase (ALE, STROBE, SELECT, READ, WRITE, and ADR[14:2]), and those that qualify data phases, (RDY_IN, RDY_OUT, BLAST, $\overline{BE}[3:0]$, and DQ[31:0]). The CY7C09449PV drives RDY_OUT to signal the need for wait states on the local processor bus as well as an indication of valid data on DQ[31:0] during read access of the CY7C09449PV. Note that several of the CY7C09449PV local bus signals have configurable polarity. These are: ALE, BLAST, RDY_OUT, and STROBE. Also, the READ and WRITE signals have special combined signal modes.

The basic local-bus cycle starts with the address phase. The address phase is defined as both STROBE and SELECT active at the rising edge of CLKIN. Also sampled at this time are the READ and WRITE signals to determine if the access is a read or write. If the access is a read, then the CY7C09449PV will begin driving the DQ bus at the next CLKIN rising edge.

There are two ways to get an address into the CY7C09449PV. With ALE tied active, the address is latched during the address phase. That is, when STROBE and SELECT are active, the address on the ADR[14:2] pins is latched on the rising edge of CLKIN. The second way is to use the trailing edge of ALE to latch the address. The CY7C09449PV still needs a valid address phase (STROBE and SELECT active at the rising edge of CLKIN) before it will begin processing the address. A valid and stable address must occur before the trailing edge of ALE and before the rising edge of CLKIN where STROBE and SELECT are active.

After the address phase come wait states and data phases. The STROBE signal can be active or inactive during wait and data phases. A data phase occurs when the RDY_IN and RDY_OUT inputs and the RDY_OUT output are all active at the rising edge of CLKIN. If any ready signal is inactive, then the next clock cycle is a wait state. The $\overline{BE}[3:0]$ pins are sampled during the data phase of write cycles to determine which data bytes are to be written. The data on the DQ pins is also latched at this time.

The BLAST signal is sampled during the data phase to determine if the last data phase is occurring. In one mode, an inactive level during the data phase indicates that there are more data phases in the transaction and that the address that was captured in the address phase should be updated. When BLAST is active during the data phase, it indicates that this is the last data phase of the transaction. In the other mode, BLAST is active during every data phase and goes inactive at the end of the last data phase. In both cases, if the access is a read, then the CY7C09449PV will stop driving the DQ bus synchronously with the rising edge of CLKIN for that data phase.

Interface Definitions

8-Bit Interface

The 8-bit interface option is selected by setting bits BW[1:0] = '00' in the Local Bus Configuration Register. Only data lines DQ[7:0] are used. The unused portion of the data bus, DQ[31:8] must be tied HIGH or LOW; the bits cannot be left

floating. The least two significant bits of the local address bus should be connected to the byte enable pins $\overline{BE}[3:2]$. $\overline{BE}[0]$ should be tied to $\overline{RDY_IN}$ which is connected normally.

Connect

- $\overline{BE}[3]$ = A1
- $\overline{BE}[2]$ = A0
- $\overline{BE}[1]$ = Logic HIGH
- $\overline{BE}[0]$ = Tie to $\overline{RDY_IN}$

BW[1:0]	BEMODE	A1, A0 ($\overline{BE}[3]$, $\overline{BE}[2]$)	DQ [7:0] Accessed Data
00	X	00	Data[7:0]
00	X	01	Data[15:8]
00	X	10	Data[23:16]
00	X	11	Data[31:24]

16-Bit Interface

The 16-bit interface option is selected by setting bits BW[1:0] = '01' in the Local Bus Configuration Register. Only data lines DQ[15:0] are used. The unused portion of the data bus, DQ[31:16] must be tied HIGH or LOW; the bits cannot be left floating. There are two basic modes for 16-bit operation. One is for Motorola-style encoded byte enables and the other is for direct byte enables. This is configured with the Byte Enable mode bit, BEMODE. There is an exception to the data bus wiring for Motorola-style buses if a 32-bit processor bus is configured to only use 16 data bits. The upper 16 bits of the processor bus are connected rather than the lower 16 bits. See the description for BEMODE='1' below.

BEMODE = '0' is for operation of other than Motorola-style byte enables. The table below shows where data on the 16-bit bus is routed within the CY7C09449PV internal data structures.

Connect

- $\overline{BE}[3]$ = A1
- $\overline{BE}[2]$ = Not used, should be tied HIGH
- $\overline{BE}[1]$ = BE1, UDS, BHE (Byte Enable 1, Upper Data Strobe, Byte High Enable)
- $\overline{BE}[0]$ = BE0, LDS, DEN (Byte Enable 0, Lower Data Strobe, Data Enable, A0)

BW[1:0]	BE-MODE	A1 ($\overline{BE}[3]$)	DQ [15:0] Bus Accessed Data
01	0	0	CY7C09449PV Data[15:0]
01	0	1	CY7C09449PV Data[31:16]

Notes:

$\overline{BE}[1:0]$ are used as byte enables. If the processor always does 16-bit accesses, then these can be tied active LOW. These byte enables can also be used for Upper Data Strobe (UDS) and Lower Data Strobe (LDS) for processors which produce these signals.

The least significant bit of the local address bus is tied to $\overline{BE}[3]$, and it *must be valid during the address phase*. This input must be incremented (toggled) at the end of each data phase. Bursts to the 16-bit interface do not need to start on a DWORD boundary. The internal DWORD address will automatically increment after a data phase where $\overline{BE}[3]$ is HIGH.

BEMODE = '1' is for operation of Motorola-style byte enables. The tables below show where data on the 16-bit bus is placed in the CY7C09449PV internal data structures. For the case where a 32-bit Motorola processor bus is to be configured for 16-bit bus operation, then connect the processor D[31:16] to CY7C09449PV DQ[15:0]. For instance, the Motorola 68360 processor may be operated in this mode. The tables show this mode of operation.

Connect for encoded byte enables

- $\overline{BE}[3] = SIZ1$ (Operand Transfer Size, bit 1)
- $\overline{BE}[2] = SIZ0$ (Operand Transfer Size, bit 0)
- $\overline{BE}[1] = A1$
- $\overline{BE}[0] = A0$

BW[1:0]	BEMODE	Interpretation
01	1	Use the following table

CY7C09449PV External $\overline{BE}[3:0]$	Interpretation -- 'byte' terminology here uses byte 3 as least significant byte of the processor's internal 32-bit data structure; the signals show pins on the processor.	CY7C09449PV Internal $\overline{BE}[3:0]$ for writes
0000	all-byte write starting at byte 0 (D[31:16]) (truncated to two bytes)	0011
0001	all-byte write starting at byte 1 (D[23:16]) (truncated to one byte)	1011
0010	all-byte write starting at byte 2 (D[31:16]) (truncated to two bytes)	1100
0011	all-byte write starting at byte 3 (D[23:16]) (truncated to one byte)	1110
0100	single-byte write starting at byte 0 (D[31:24])	0111
0101	single-byte write starting at byte 1 (D[23:16])	1011
0110	single-byte write starting at byte 2 (D[31:24])	1101
0111	single-byte write starting at byte 3 (D[23:16])	1110
1000	two-byte write starting at byte 0 (D[31:16])	0011
1001	two-byte write starting at byte 1 (D[23:16]) (truncated to one byte)	1011
1010	two-byte write starting at byte 2 (D[31:16])	1100
1011	two-byte write starting at byte 3 (D[23:16]) (truncated to one byte)	1110
1100	three-byte write starting at byte 0 (D[31:16]) (truncated to two bytes)	0011
1101	three-byte write starting at byte 1 (D[23:16]) (truncated to one byte)	1011
1110	three-byte write starting at byte 2 (D[31:16]) (truncated to two bytes)	1100
1111	three-byte write starting at byte 3 (D[31:24]) (truncated to one byte) three-byte read starting at byte 3 (D[23:16]) (truncated to one byte)	1110

32-Bit Interface

The 32-bit interface option is selected by setting bits BW[1:0] = '10' or BW[1:0] = '11' in the Local Bus Configuration Register. Data lines DQ[31:0] are used. With BW[1:0] = '10', the byte enables are used directly as byte write enables. With BW[1:0] = '11', however, the meaning of the byte enables is determined from the following tables (based on BEMODE).

For 32-bit processor bus interfaces like the Motorola 68020 or 68030, BW = '11' and BEMODE = '0' settings are used. This supports a special style of using byte addressing instead of fully decoded byte enables. The SIZ1 and SIZ0 signals of the 68020 are connected to the BE[3] and BE[2] pins, respectively,

and the A1 and A0 signals are connected to the $\overline{\text{BE}}[1]$ and $\overline{\text{BE}}[0]$ pins on the CY7C09449PV.

Connect for encoded byte enables

- $\overline{\text{BE}}[3]$ = SIZ1 (Operand Transfer Size, bit 1)
- $\overline{\text{BE}}[2]$ = SIZ0 (Operand Transfer Size, bit 0)
- $\overline{\text{BE}}[1]$ = A1
- $\overline{\text{BE}}[0]$ = A0

BW[1:0]	BEMODE	Interpretation
10	X	Use byte enables for all 4 byte lanes
11	0	Use the following table

CY7C09449PV External $\overline{\text{BE}}[3:0]$	Interpretation -- 'byte' terminology here uses byte 3 as least significant byte of the processor's internal 32-bit data structure; the signals show pins on the processor	CY7C09449PV Internal $\overline{\text{BE}}[3:0]$ for writes
0000	all-byte write starting at byte 0 (D[31:0])	0000
0001	all-byte write starting at byte 1 (D[23:0]) (truncated to three bytes)	1000
0010	all-byte write starting at byte 2 (D[15:0]) (truncated to two bytes)	1100
0011	all-byte write starting at byte 3 (D[7:0]) (truncated to one byte)	1110
0100	single-byte write starting at byte 0 (D[31:24])	0111
0101	single-byte write starting at byte 1 (D[23:16])	1011
0110	single-byte write starting at byte 2 (D[15:8])	1101
0111	single-byte write starting at byte 3 (D[7:0])	1110
1000	two-byte write starting at byte 0 (D[31:16])	0011
1001	two-byte write starting at byte 1 (D[23:8])	1001
1010	two-byte write starting at byte 2 (D[15:0])	1100
1011	two-byte write starting at byte 3 (D[7:0]) (truncated to one byte)	1110
1100	three-byte write starting at byte 0 (D[31:8])	0001
1101	three-byte write starting at byte 1 (D[23:0])	1000
1110	three-byte write starting at byte 2 (D[15:0]) (truncated to two bytes)	1100
1111	three-byte write starting at byte 3 (D[7:0]) (truncated to one byte)	1110

For 32-bit processor bus interfaces like the Motorola 68040, BW = '11' and BEMODE = '1' settings are used. This supports a special style of using byte addressing instead of fully decoded byte enables. The SIZ1 and SIZ0 signals of the 68040 are connected to the BE[3] and BE[2] pins, respectively, and the A1 and A0 signals are connected to the $\overline{\text{BE}}[1]$ and $\overline{\text{BE}}[0]$ pins on the CY7C09449PV. A cache-line fill is triggered using the SIZ1 and SIZ0 pins on the 68040-type bus. When these bits

are set to '11', the CY7C09449PV will interpret this as a burst-of-four, ignoring the burst last signal BLAST.

BW[1:0]	BEMODE	Interpretation
11	1	Use the following table

CY7C09449PV External BE[3:0]	Interpretation -- the signals show pins on the processor	CY7C09449PV Internal BE[3:0] for writes
00xx	32-bit write D[31:0]	0000
0100	8-bit write D[31:24]	0111
0101	8-bit write D[23:16]	1011
0110	8-bit write D[15:8]	1101
0111	8-bit write D[7:0]	1110
100x	16-bit write D[31:16]	0011
101x	16-bit write D[15:0]	1100
11xx ^[1]	burst of four 32-bit writes, $\overline{\text{BLAST}}$ not used	0000

Timing Diagrams

Write Cycle

A basic write cycle is illustrated below. It includes a burst of three data phases on a 32-bit wide bus.

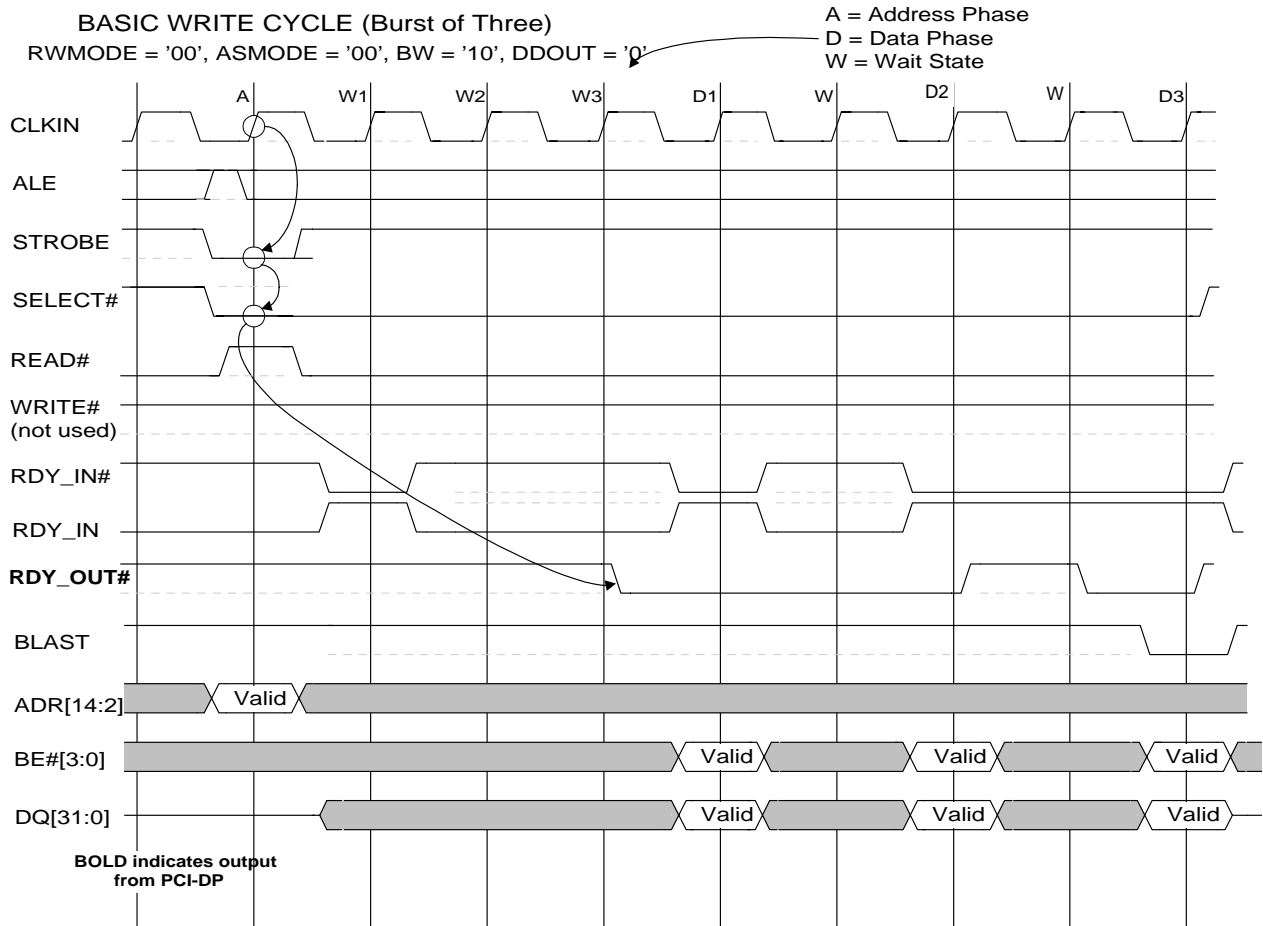

Note:

1. This encoding, {BW[1:0], BEMODE, BE[3:2]} = {'11111'}, results in a burst of four DWORD. $\overline{\text{BLAST}}$ should remain active.

Read Cycle

The basic read cycle differs from the write cycle only in the level of the READ and WRITE signals, and the timing and

driving of the data bus DQ. A basic read burst of four data phases on a 32-bit wide bus is illustrated.

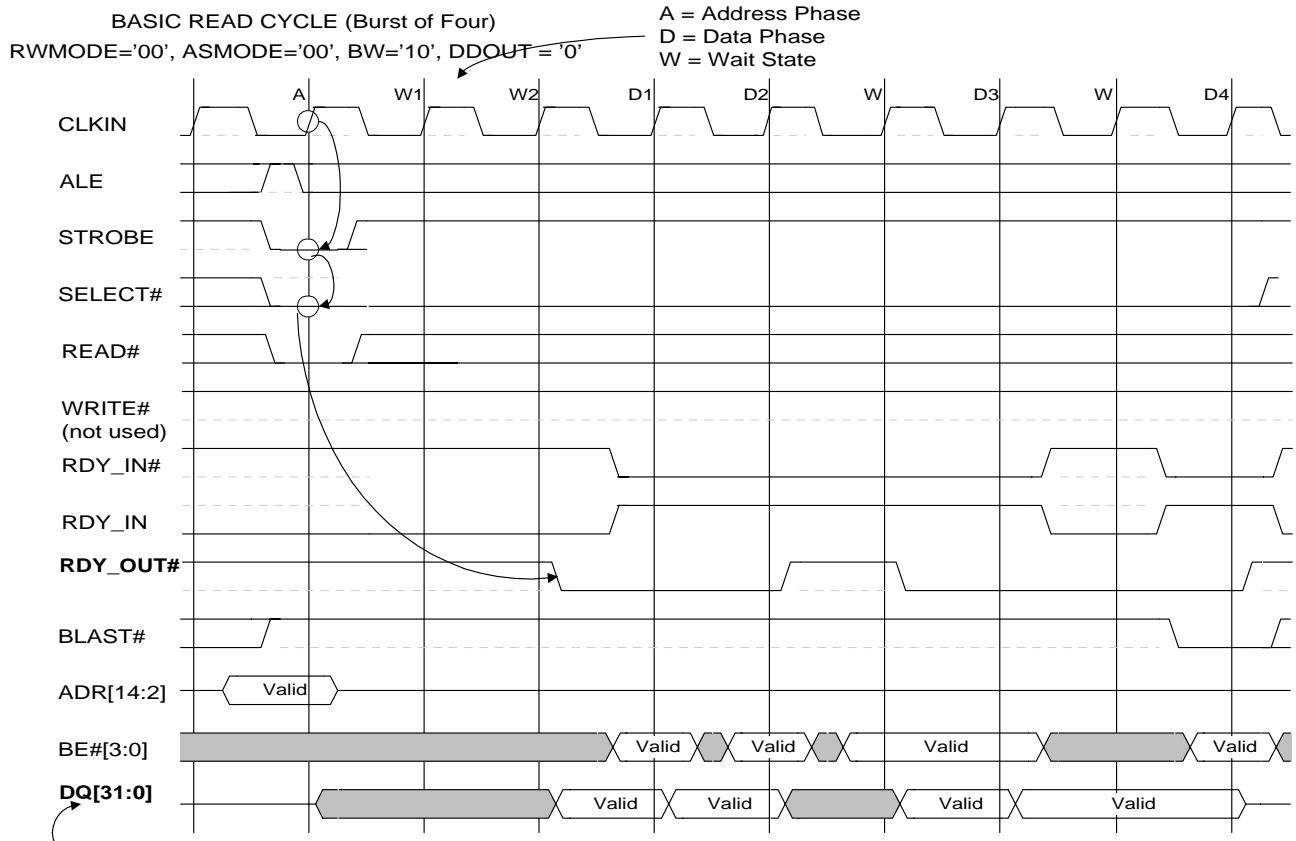

Basic 8-bit Interface

The following two waveforms illustrate the operation of the 8-bit interface mode. Note that only data lines DQ[7:0] are used. DQ[31:8] are unused and must be tied high or low; they cannot be left floating. The least significant bits of the local address, A[1] and A[0], must be connected to the byte enable pins BE[3] and BE[2], respectively. These must be valid during the address phase.

In burst operation, BE#[3:2] are inputs used at A1 and A0 of the local address bus. Bursts to the 8-bit interface do not need to start on a DWORD boundary. The internal DWORD address will automatically increment after a data phase where BE[3:2] equals '11', (A[1:0] = '11').

The first waveform illustrates single cycle operation and the second illustrates data burst operation.

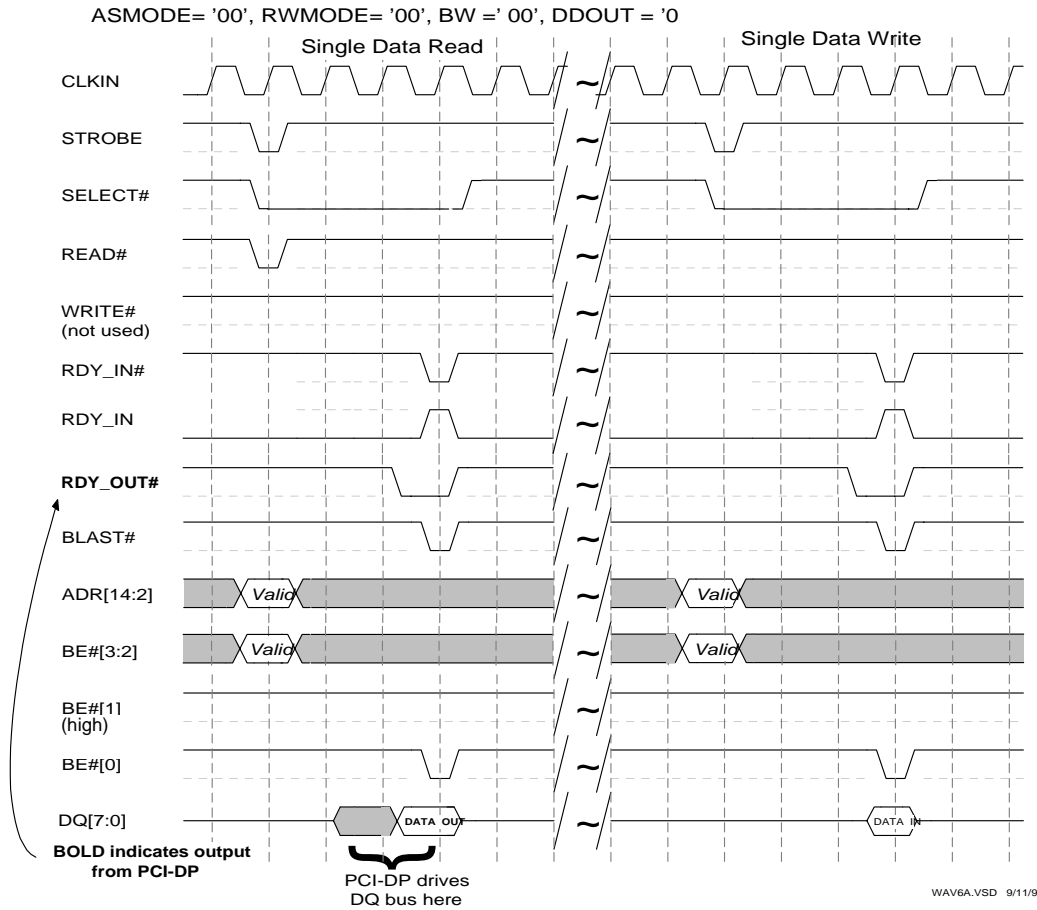

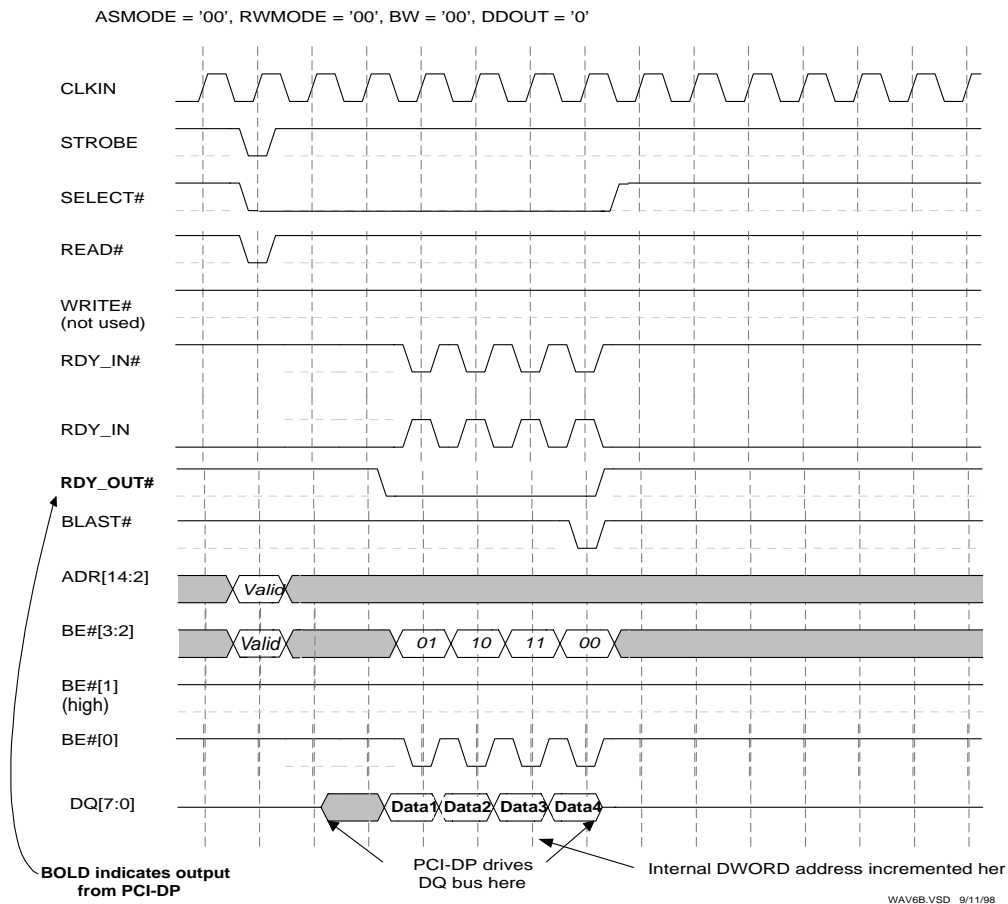

Basic 16-bit Interface

The following two waveforms illustrate the operation of the 16-bit interface mode. Note that only data lines DQ[15:0] are used. DQ[31:16] are unused and must be tied HIGH or LOW; they cannot be left floating. The least significant bit of the local address of the 16-bit bus, A[1], must be connected to the byte enable pin $\overline{BE}[3]$. It must be valid during the address phase.

Note that $\overline{BE}[1:0]$ are used as byte enables. If the processor always does 16-bit accesses, then these can be tied active LOW. These byte enables can also be used for Upper Data

Strobe (UDS) and Lower Data Strobe (LDS) for processors which produce these signals.

In burst operation, $\overline{BE}[3]$ must be incremented (toggled) at the end of each data phase. Bursts to the 16-bit interface do not need to start on a DWORD boundary. The internal DWORD address will automatically increment after a data phase where $\overline{BE}[3]$ equals '1', ($A[1] = '1'$).

The first waveform illustrates single cycle operation and the second illustrates data burst operation.

ASMODE = '00', RWMODE = '00', BW = '01', DDOUT = '0' OUT = '0'

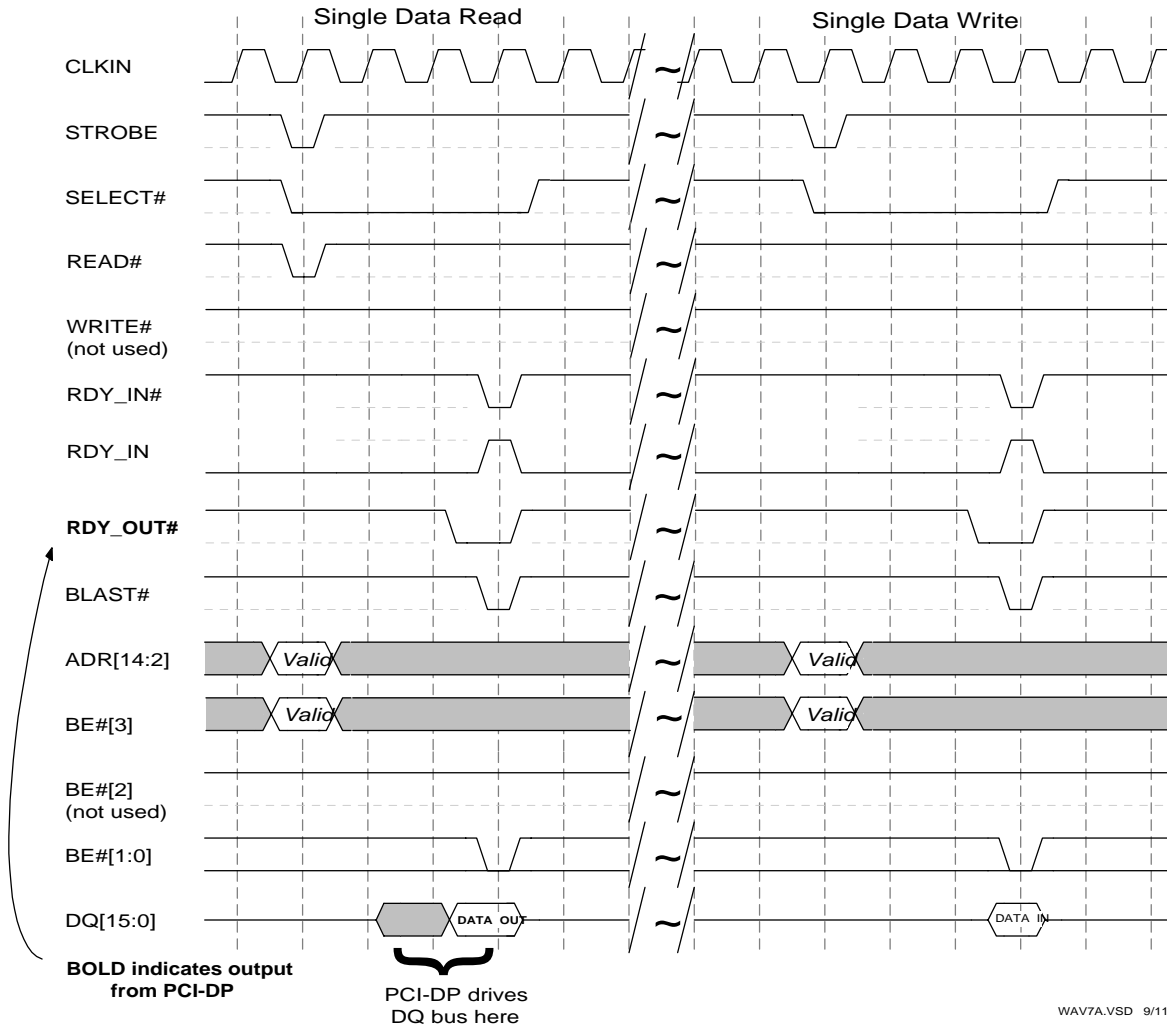

ASMODE = '00', RWMODE = '00', BW = '01', DDOUT = '0'

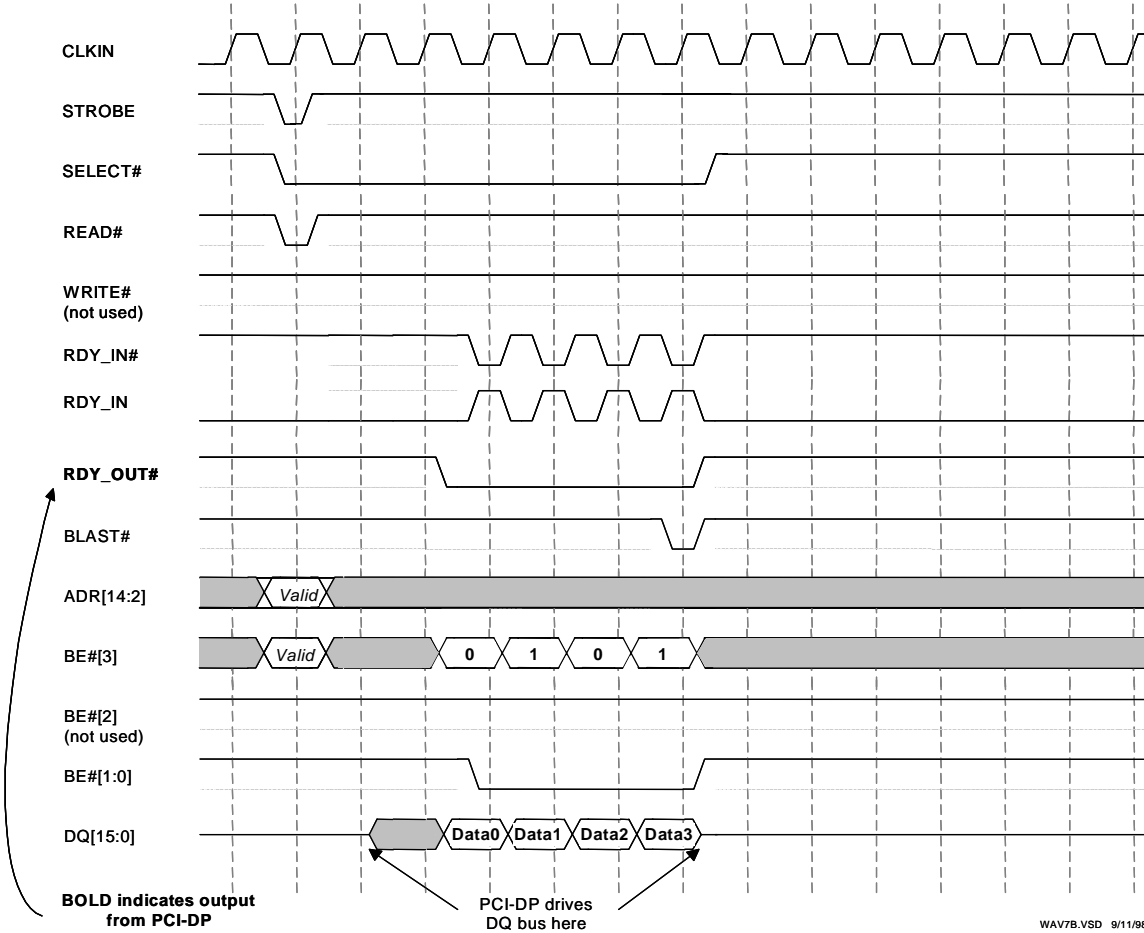

ALE—Address Latch Enable

The ALE signal may be used in two modes. With ALE tied active, the address is latched during the address phase. That is, when the $\overline{\text{STROBE}}$ and $\overline{\text{SELECT}}$ signals are active, the address on the ADR[14:2] pins is latched on the rising edge of CLKIN. The second way is to use the trailing edge of ALE to latch the address. The CY7C09449PV still needs a valid ad-

dress phase ($\overline{\text{STROBE}}$ and $\overline{\text{SELECT}}$ active at the rising edge of CLKIN) before it will begin processing the address. A valid and stable address must occur before the trailing edge of ALE and before the rising edge of CLKIN where $\overline{\text{STROBE}}$ and $\overline{\text{SELECT}}$ are active. The active polarity of ALE is defined in the Operations Registers: ALE_POL of the Local Bus Configuration Register.

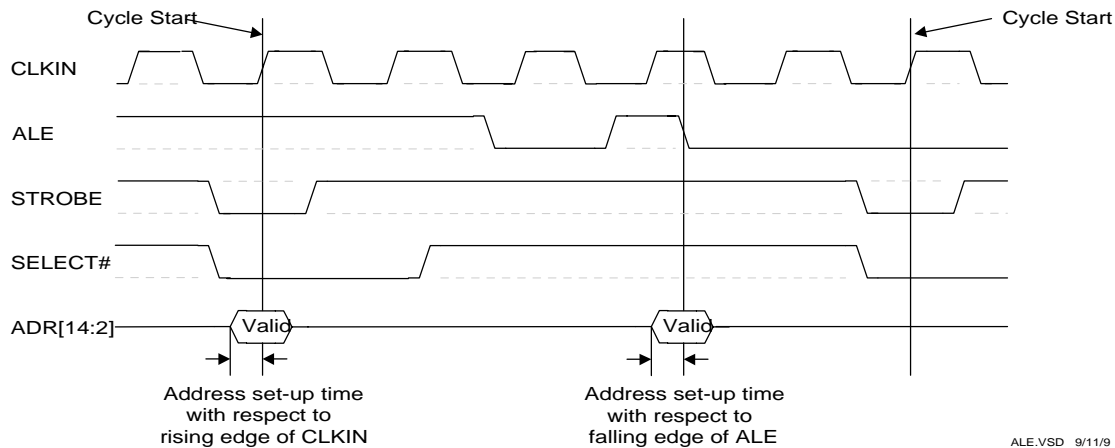

RDY_OUT_OE—Ready Out Three-state Mode

The $\overline{\text{RDY_OUT}}$ signal may be configured to drive at all times or to three-state when inactive. The three-state mode is a sustained deasserted function. In three-state mode, when $\overline{\text{RDY_OUT}}$ is to go inactive, $\overline{\text{RDY_OUT}}$ is driven to the deasserted level for one clock, and then three-stated. It remains three-stated until $\overline{\text{RDY_OUT}}$ is to be asserted. The logic polarity of $\overline{\text{RDY_OUT}}$ is programmable. The mode (RDY_OUT_OE) and polarity (RDYOUT_POL) controls are set in the Local Bus Configuration Register, LBUSCFG , of the Operations Registers.

DDOUT—Delayed Data Out

The delayed data out control defines when the CY7C09449PV drives the DQ bus during a local bus read. The control is defined in the Operations Registers: DDOUT of the Local Bus Configuration Register. When $\text{DDOUT} = '0'$, the CY7C09449PV will drive the DQ bus during a read starting one clock after the address phase and stop driving at the clock edge where both of the ready inputs and BLAST\# are active. When $\text{DDOUT} = '1'$, the CY7C09449PV will drive the DQ bus during a read starting one CLKIN clock after the address phase and stop driving one clock after the clock edge where the two ready inputs and BLAST are active. The data is driven for one clock period after the signal that the transaction is over. In the case of multiple data phases, it adds one clock cycle to the starting latency of the burst.

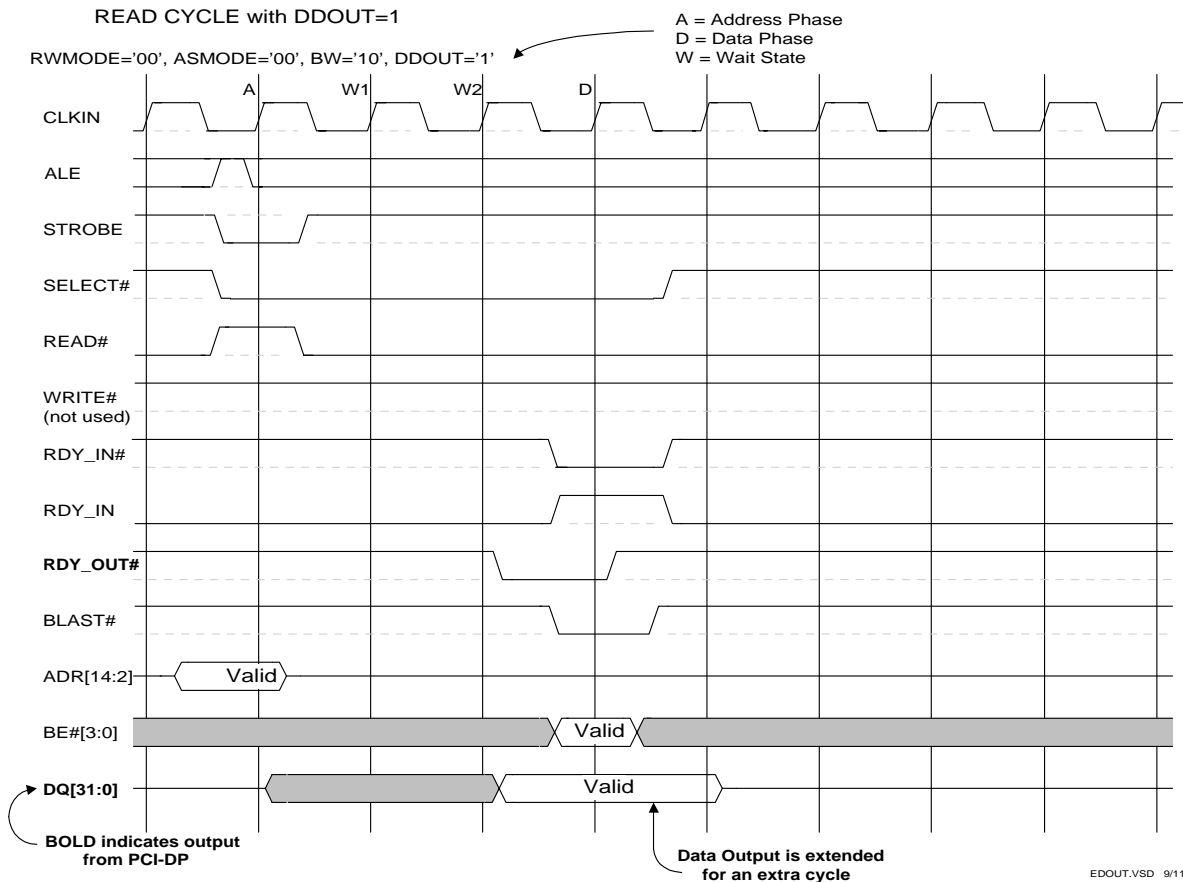
RDY_OUT—Ready Out

STROBE can be active or inactive during data phases. However, if STROBE is active during the data phase when BLAST is active AND the extended ready out control (XTND_RDY_OUT) is set, the CY7C09449PV keeps RDY_OUT active until STROBE goes inactive. In the case of a read, the CY7C09449PV will continue to drive the data on DQ until STROBE is deasserted.

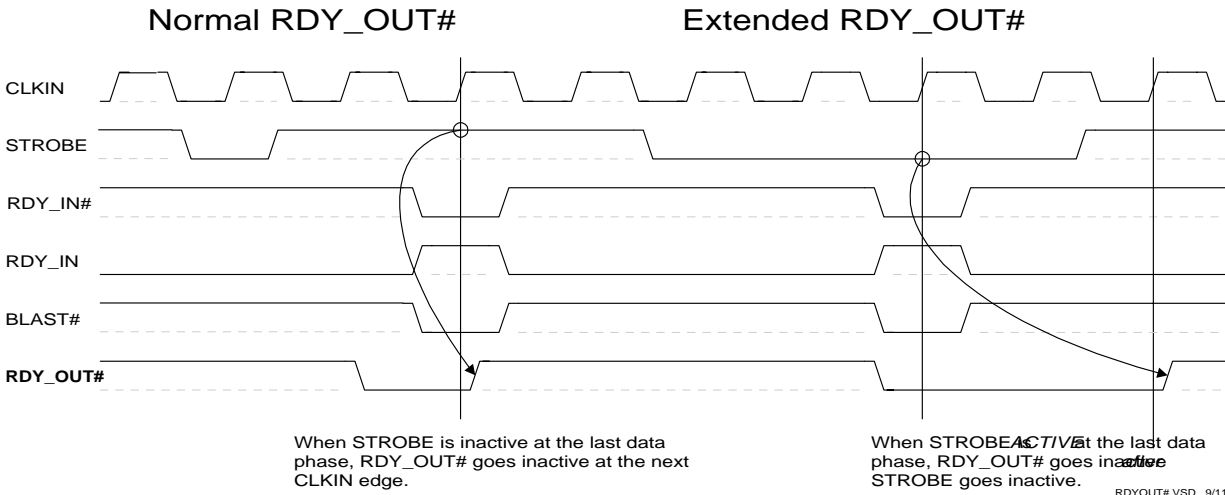

LINE_WRAP_DIS—Cache Line Wrap Disable

This setting is used to disable cache line wrapping, `LINE_WRAP_DIS = '1'`. Cache line wrapping only occurs when the local bus interface is set for 32 bit width with encoded byte enables, using the Motorola byte enable encoding, and the bus `SIZ` bits indicate a cache line access. Specifically, this is when `BW = '11'`, `BEMODE = '0'`, and `BE[3] = BE[2] = '1'`. If a cache line access is made and cache line wrapping is disabled, then the burst will proceed linearly with no implicit address wraparound at the 4 DWORD boundary.

ASMODE—Address Strobe Mode

The address strobe mode control defines the polarity and the timing used to sample the CY7C09449PV address strobe input signal, `STROBE`. The two-bit control field is defined in the Operations Registers: `ASMODE` of the Local Bus Configuration Register.

`ASMODE[0]` defines the polarity of the `STROBE` input signal; '0' = active LOW and '1' = active HIGH.

`ASMODE[1]` controls the sampling edge of the `STROBE` signal. Logic LOW indicates that the signal is sampled using the rising edge of `CLKIN`. A logic HIGH indicates that the signal is sampled with the falling edge of `CLKIN`. Sampling on the falling edge should only be used when the required minimum set-up time with respect to the clock rising edge cannot be met on the signals.

The following waveform illustrates the operation of the `ASMODE[1]` pin. `ADR` and `READ` are sampled at E2, and a valid write occurs at E4. Note that `STROBE` is captured at the negative edge labeled NE1 and that the `ADR` and `READ` signals are sampled at the positive clock edge labeled E2. Also note that the ready signals are sampled at the negative edge labeled NE4 and not at the positive edge labeled E5. `STROBE` is active LOW since `ASMODE[0] = '0'`.

ASMODE[1]='1' (32-bit write, single data phase)
 RWMODE='00', ASMODE='10', BW='10', DDOUT = '0'

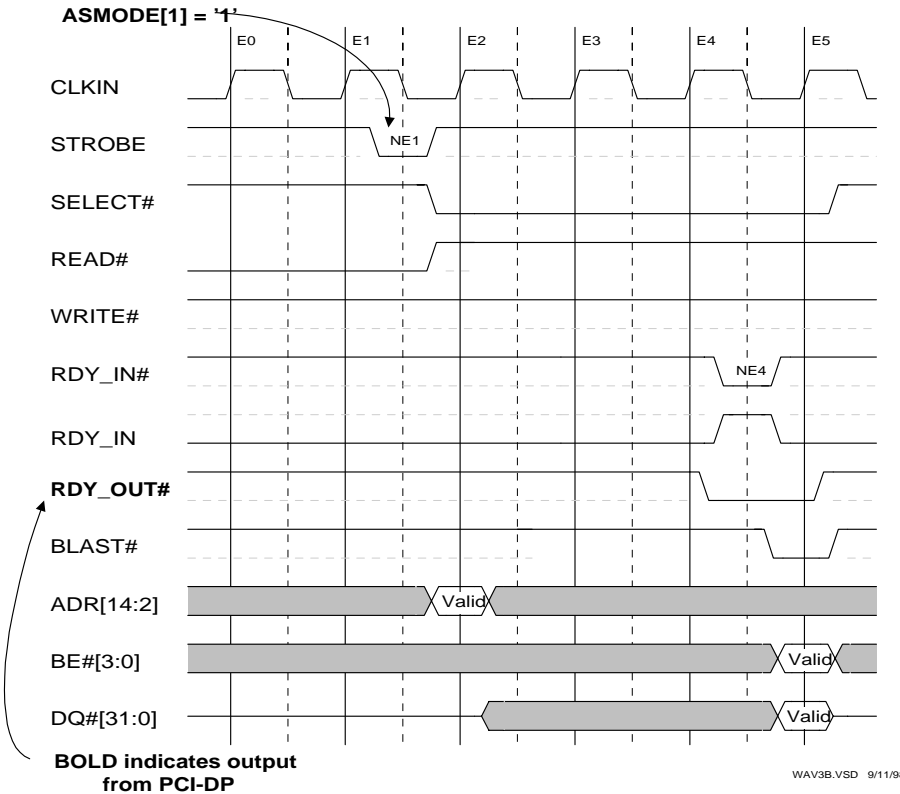

Falling Edge Sampling for RDY_IN, RDY_IN, SELECT, and STROBE

These signals may be configured for falling edge sampling within the Local Bus Configuration Register (LBU SCFG) of the Operations Registers. RDY_IN and RDY_IN sampling is configured by the RDY_IN_FALL bit, SELECT sampling is configured by the SELECT_FALL bit, and STROBE sampling is configured by the ASMODE[1] bit. Setting any one or all of these bits will not effect the sampling of other signals on the local bus. That is, all other signals that are synchronous inputs are sampled on the rising edge of the local bus clock, CLKIN. When a negative edge sample is used, the other signals are qualified by that sample on the immediately following rising edge of CLKIN. For example, study the prior waveform illustrating operation of ASMODE. In that diagram, STROBE is configured to sample on the falling edge of CLKIN because

ASMODE[1]='1'. An active STROBE indicates an address phase. The valid address is captured on the first rising clock edge after STROBE is sampled active.

RWMODE—Read Write Mode

The read write mode control defines how the address strobe (STROBE), read (READ), and write (WRITE) input signals are interpreted by the CY7C09449PV internal logic. The two-bit control field is defined in the Operations Registers: RWMODE of the Local Bus Configuration Register. Each of the four cases for RWMODE are illustrated in the following four diagrams.

Use RWMODE = '00' to interface to a processor that has a read-write signal defined as W_R (write is logic 1, read is logic 0). In this mode, the WRITE is not used and should be tied HIGH. A write cycle is illustrated below.

RWMODE='00', ASMODE='00', BW='10', DDOUT = '0'

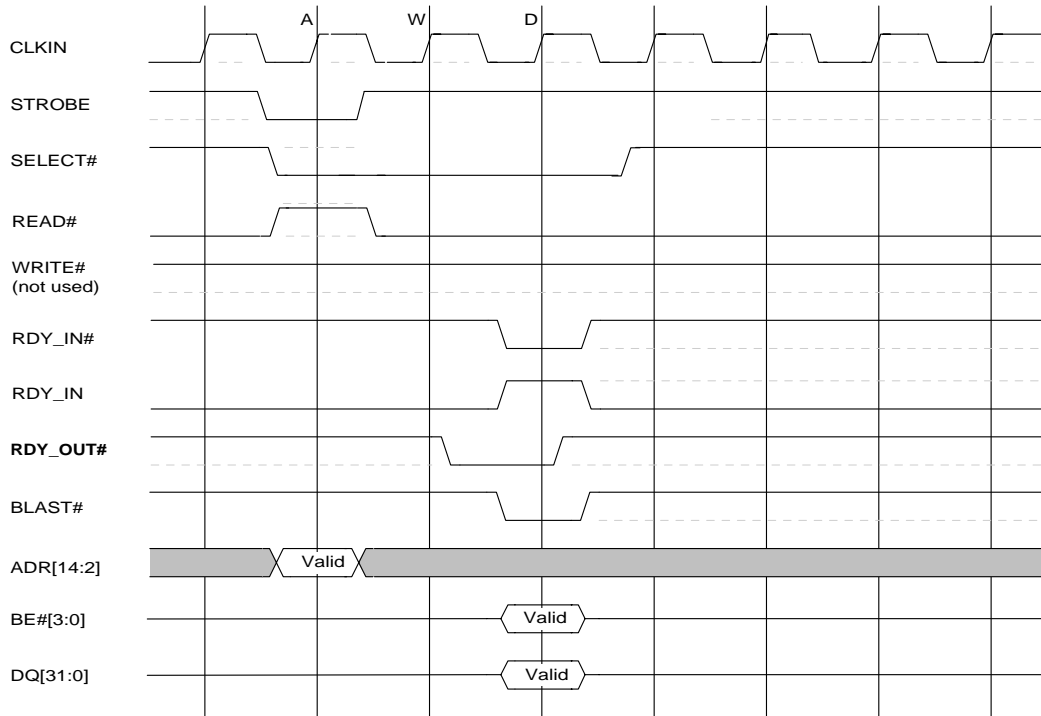

Use RWMODE = '01' to interface to a processor that has a read-write signal defined at R_W (write is logic 0, read is logic 1). In this mode, the WRITE acts as R_W and it is sampled

when **SELECT** and **STROBE** are both active. The **READ** pin is not used and should be tied HIGH. This is illustrated below.

RWMODE='01', ASMODE='00', BW='10', DDOUT = '0'

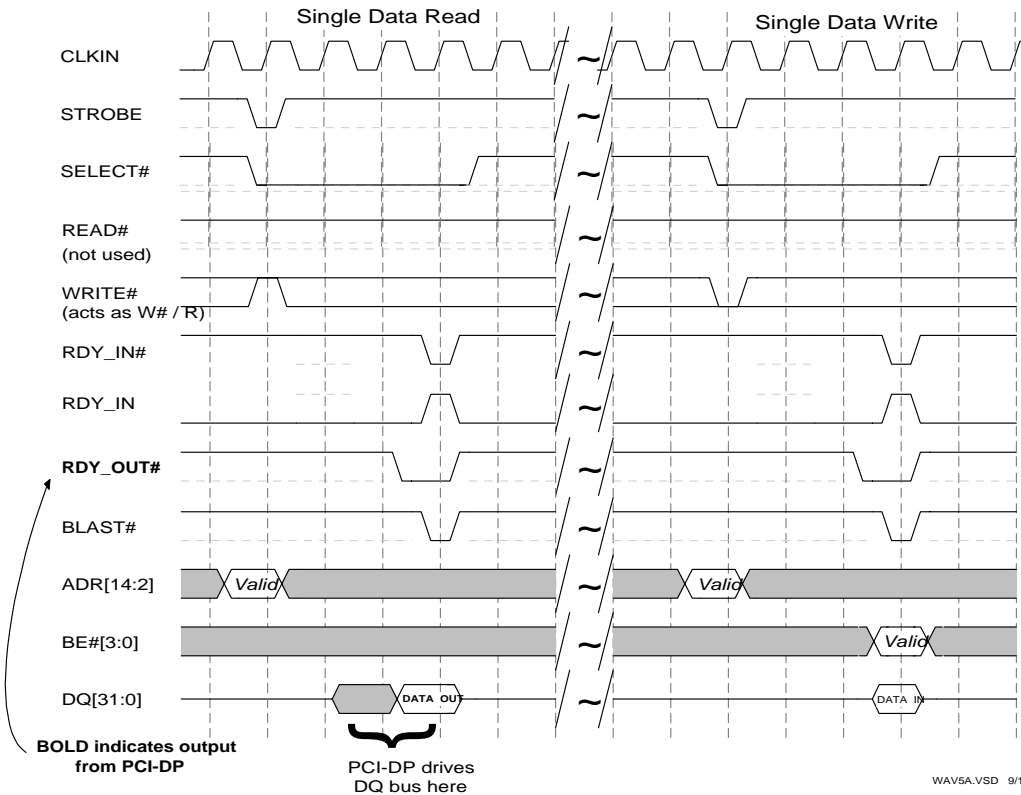

WAV5A.VSD 9/11/9

Use RWMODE = '10' or RWMODE = '11' to interface to a processor that has separate active LOW read and write signals. The two modes are identical. Sampling of the READ and

WRITE signals is used as the internal address strobe in place of the STROBE signal. This is illustrated below.

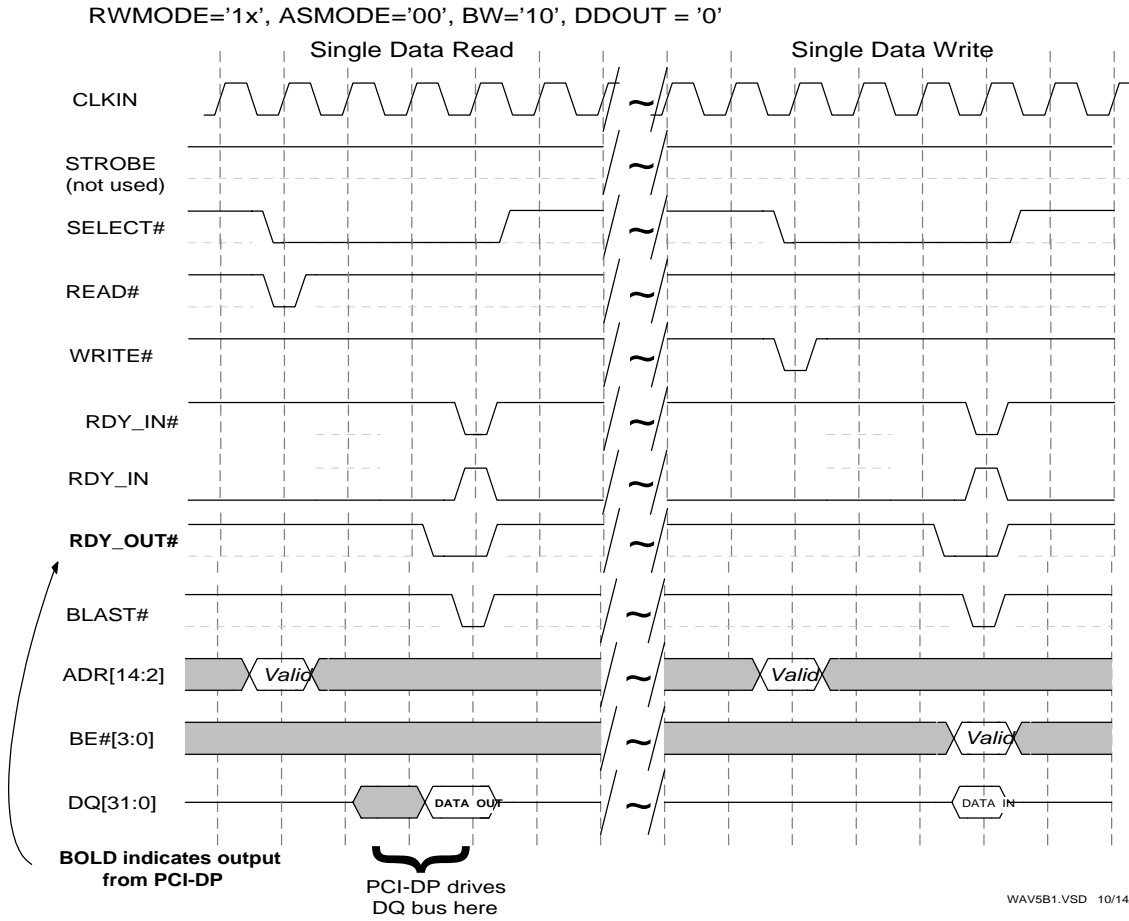

I²C Serial Port and Auto-Configuration

The CY7C09449PV I²C serial port may master the I²C bus, but it is not a target on the bus. Read and write access to the port is available to both the PCI and Local buses via the I²C programming Operations Registers. The CY7C09449PV supports single byte device internal addressing. The port can be used for Auto-Configuration of the CY7C09449PV as well as for basic read and write access to I²C-compatible devices connected to the port.

Auto-Configuration is the function that uses the port to load CY7C09449PV configuration information. A typical device containing the data is a serial Electrically Erasable Programmable Read Only Memory (EEPROM). The EEPROM includes data for some PCI configuration registers and some Operations Registers. The EEPROM containing the CY7C09449PV configuration data must be located at I²C device address 0x0 and must contain the proper CY7C09449PV Signature. For details, see the memory map below and the accompanying field descriptions.

I ² C Serial Port Device 0x0 Memory Map for Auto-Configuration				
Byte 3	Byte 2	Byte 1	Byte 0	Internal Address, Byte Offset
don't care	don't care	don't care	don't care	0x00 ... 0x3F
CY7C09449PV Signature 0x48	CY7C09449PV Signature 0x37	reserved	reserved	0x40
Device ID high byte	Device ID low byte	Vendor ID high byte	Vendor ID low byte	0x44
Class Code , base class high byte	Class Code , sub-class middle byte	Class Code , programming intf. low byte	Revision ID	0x48
Subsystem Device ID high byte	Subsystem Device ID low byte	Subsystem Vendor ID high byte	Subsystem Vendor ID low byte	0x4C
MAX_LAT	MIN_GNT	Interrupt Pin, Master Enable ^[2]	don't care	0x50
Cardbus CIS Pointer high byte	Cardbus CIS Pointer low byte	Cardbus CIS Pointer high byte	Cardbus CIS Pointer low byte	0x54
reserved	reserved	reserved	reserved	0x58
reserved	reserved	reserved	reserved	0x5C
reserved	reserved	reserved	reserved	0x60
reserved	reserved	reserved	reserved	0x64
reserved	reserved	reserved	reserved	0x68
reserved	Local Bus Configuration high byte	Local Bus Configuration middle byte	Local Bus Configuration low byte	0x6C
reserved	reserved	reserved	reserved	0x70
Host Control bits [31:24]	Host Control bits [23:16]	Host Control bits [15:8]	Host Control bits [7:0]	0x74
don't care	don't care	don't care	don't care	0xFF ... 0x78

Notes:

2. Master Enable is the most significant bit of this byte; see text for more description of this flag.
3. The recommended value for reserved data in the EEPROM is '1'

CY7C09449PV Signature

Address: 0x43 - 0x42

Device Configuration Signature: A valid EEPROM CY7C09449PV configuration image is indicated at this address by the value of 0x4837. It is read from the EEPROM at I²C device address 0x0 immediately after the CY7C09449PV comes out of reset. The CY7C09449PV comes out of reset as indicated by the deassertion of the CY7C09449PV RST input. Upon recognition of a valid signature, the contents of the EEPROM will be transferred to the appropriate CY7C09449PV registers. The appropriate registers are indicated by the other labeled fields of the I²C Serial Port Device 0x0 Memory Map for Auto-Configuration and are described in this section. If the value at this location is not 0x4837, then the transfer will not occur and the default (reset) values for the CY7C09449PV registers will remain in effect after the CY7C09449PV comes out of reset.

Vendor ID

Address: 0x45 - 0x44

PCI Configuration Vendor ID: the meaning of this field is described in the PCI Bus section.

Device ID

Address: 0x47 - 0x46

PCI Configuration Device ID: the meaning of this field is described in the PCI Bus section.

Revision ID

Address: 0x48

PCI Configuration Revision ID: the meaning of this field is described in the PCI Bus section.

Class Code

Address: 0x4B - 0x49

PCI Configuration Class Code (Base Class, Sub-Class, Programming Interface): the meaning of this field is described in the PCI Bus section.

Subsystem Vendor ID

Address: 0x4D - 0x4C

PCI Configuration Subsystem Vendor ID: the meaning of this field is described in the PCI Bus section.

Subsystem Device ID

Address: 0x4F - 0x4E

PCI Configuration Subsystem Device ID: the meaning of this field is described in the PCI Bus section.

Interrupt Pin

Address: 0x51, bits 2, 1, 0

PCI Configuration Interrupt Pin: the meaning of this field is described in the PCI Bus section.

Master Enable

Address: 0x51, bit 7

PCI Configuration Command Bit 2: enable PCI bus master operation. For a host bridge, this typically must be set to allow the host to configure itself and configure and access other de-

vices on the PCI bus. Even though an external master can manipulate the PCI Command register, it is typical that the host is the first device to configure devices on the PCI bus. Since the default value for PCI Command bit 2 is that PCI bus mastering is disabled, the Master Enable bit in the EEPROM image should be set to enable PCI mastering.

MIN_GNT

Address: 0x52

PCI Configuration MIN_GNT: the meaning of this field is described in the PCI Bus section.

MAX_LAT

Address: 0x53

PCI Configuration MAX_LAT: the meaning of this field is described in the PCI Bus section.

Cardbus CIS Pointer

Address: 0x57 - 0x54

PCI Configuration Cardbus CIS Pointer: the meaning of this field is described in the PCI Bus section.

Local Bus Configuration

Address: 0x6C - 0x6E

Operations Registers Local Bus Configuration: the detailed meaning of this field is described in the Operations Registers section. For the CY7C09449PV Local bus to exhibit the correct protocol, the Local Bus Configuration Operations Register needs to be loaded before the CY7C09449PV is accessed via the Local bus interface. The Local bus interface circuitry will be held in reset until transfer of the EEPROM configuration data is complete. At such completion, and dependent upon the state of the Host Control Operations Register, the Local bus will be available for access using the programmed Local bus interface protocol.

Host Control

Address: 0x77 - 0x74

Operations Registers Host Control: Only bits 1 and 0 have meaning; the other bits are reserved. When programming bits 1 and 0, other bits of the DWORD should be written with '0'.

One of two reset controls from the CY7C09449PV may be used to reset the local processor system. The CY7C09449PV RSTOUT output signal is a buffered copy of the PCI bus RST signal and is not conditioned by the bits of the Host Control register. This signal will deassert before the Auto-Configuration process completes, so some applications will not use this signal in order to prevent premature local processor attempts to access the CY7C09449PV.

The other form of reset control provides a direct link to the Auto-Configuration process. Using this method, the local processor will remain in reset until completion of the Auto-Configuration process. In this case, the CY7C09449PV RSTOUTD output signal (or its active HIGH version, RSTOUTD) is used to reset the local processor. This signal is a copy of bit 0 of the Host Control register (the Local Processor Reset). With Auto-Configuration, the local processor will be either held in reset or released from reset depending upon the value in the EEPROM. Furthermore, as an Operations Register, the Host Control register may be accessed from the PCI bus once Auto-Configuration is complete. Therefore, if it is desired that the

local processor be held in reset until updated by a command over the PCI bus, bit 0 of this field should be set.

Bit 1 of the Host Control register should be cleared in most cases. Setting it to '1' will reset the Operations Registers to their default state and thereby reinitialize the Local Bus Configuration register. This bit is typically used only for debug or maintenance operations. Another seldom used operation is setting the Host Control register from the local processor. Even though the Operations Register is available from the Local bus, setting either bit 0 or bit 1 to '1' will lock-out the local processor from accessing the CY7C09449PV by way of the Local bus interface.

Operations Registers

These registers are the means by which CY7C09449PV functions are accessed. Access is available via either interface, the PCI bus or the Local bus. The Operations Registers include the PCI Bus Mastering registers (DMA), the I₂O messaging unit registers, the interrupt registers, the mail boxes, and the direct access register. Also included in the Operations Registers are the initialization and configuration registers used to customize the CY7C09449PV operation to the user's needs. The critical Host Control Register and Local Bus Configuration Register may be programmed during the system initialization process. Programming via the I²C serial is available for this purpose.

The Operations Registers reside in the Local bus clock domain, therefore, a clock must be applied to CLKIN for proper operation of the CY7C09449PV. Either an external clock may

be provided or one of the CY7C09449PV PCLKOUT[2:0] signal outputs may be used. PCLKOUT is a copy of the PCI Clock input, CLK. The PCLKOUT signals are intended to be an option for the user to connect to other circuits as well.

Also available to support other circuits, the user may connect any or all of the three reset outputs from the CY7C09449PV. RSTOUT is a registered copy of the PCI Reset input, RST. It is synchronous to CLKIN. The other two reset output signals, RSTOUTD and RSTOUTD, are the copy of a bit in an Operations Register, the 'R' bit of the Host Control Register. RSTOUTD and RSTOUTD are complements of each other and are synchronous to CLKIN. Upon power-up reset of the CY7C09449PV (via the PCI Reset RST) this bit will be set active. It may be cleared during the start-up process using the I²C serial interface or it may be cleared or set via commands received over the PCI bus. Therefore, these signals may be used to hold a local processor in reset until CY7C09449PV configuration is complete or when a host is ready to release the local processor to begin its operations.

Operations Registers Addresses

This is a summary table of the CY7C09449PV Operations Registers. Register locations are the offset from the Base Address Register 0 and are DWORD aligned. The value shown is the address of the least significant byte of the register offset. Default, power-up values are also shown. Both numbers are documented in hexadecimal notation. Bit positions in gray are unused and read back as '0' unless otherwise indicated in the default value.

Operations Register										Offset / Mnemonic					
31	24	23	16	15	8	7	0			Default Value					
I²O Host Interrupt Status Register										0x0030	I2OHISR				
										I	0x00000000				
I²O Host Interrupt Mask Register										0x0034	I2OHIMR				
										M	0xFFFFFFFF				
I²O Local Interrupt Status Register										0x0038	I2OLISR				
										I	0x00000000				
I²O Local Interrupt Mask Register										0x003C	I2OLIMR				
										M	0xFFFFFFFF				
I²O FIFO Access										all default as empty FIFO, read as 0xFFFFFFFF					
Inbound Free FIFO (read only) and Inbound Post FIFO (write only)										0x0040	IBPFFIFO				
Outbound Post FIFO (read only) and Outbound Free FIFO (write only)										0x0044	OBPFFIFO				
Inbound Post FIFO (read only) and Inbound Free FIFO (write only)										0x0048	IBPFFIFO				
Outbound Free FIFO (read only) and Outbound Post FIFO (write only)										0x004C	OBPFFIFO				
Direct Access										0x0460	DAHBASE				
PCI Physical Base Address (4 Gbyte, 8 Kb blocks)										F	A1A0	BE for Reads	PCI	0xFFFFFFFF	
I²C Serial Command Register (write only)										0x04A0	NVCMD				
Device Address		Memory Address		Write Data		T		R		n/A					
I²C Serial Read Data Register										0x04A4	NVREAD				
Byte 3		Byte 2		Byte 1		Byte 0				0xFFFFFFFF					
I²C Serial Status Register										0x04A8	NVSTAT				
										ACK	0x000000XX				
DMA Local Base Address Register										0x04B0	DMALBASE				
										Local Base Address (16 Kbyte)	0x0000XXXX				
DMA Host Base Address Register										0x04B4	DMAHBASE				
PCI Base Address (4 Gbyte)											0xFFFFFFFF				
DMA Burst Size Register										0x04B8	DMASIZE				
										DMA Burst Size (16K byte)	0x0000XXXX				
DMA Control Register										0x04BC	DMACTL				
										L	P	PI	W	0x0000000X	
Arbitration Utility Flag Register										0x04C0	ARBUTIL				
		L ₃	P ₃			L ₂	P ₂			L ₁	P ₁	L ₀	P ₀	0x00000000	
Host Control										0x04E0	HCTL				
										S	R	0x00000001			
Host Interrupt Control/Status										0x04E4	HINT				
					Interrupt Enable					Interrupt Status					0x00000000
Host to Local Data Mailbox										0x04E8	HLDATA				
		I	Byte 1		Byte 0						0x0000XXXX				
Local Processor Interrupt Control/Status										0x04F4	LINT				
					Interrupt Enable					Interrupt Status					0x00000000
Local to Host Data Mailbox										0x04F8	LHDATA				
		I	Byte 1		Byte 0						0x0000XXXX				
Local Bus Configuration										0x04FC	LBUSCFG				
										Local Bus Configuration	0x00010B50				

Operations Registers Descriptions

Detailed descriptions of the Operations Registers follow. Register locations are the offset from the Base Address Register 0 and are DWORD aligned. The value shown is the address

of the least significant byte of the register offset. The offsets are documented in hexadecimal notation. Unused bits are grayed-out. Unused bits are read as '0' unless otherwise indicated.

I₂O Registers
I₂O Host Interrupt Status Register - I2OHISR0x0030

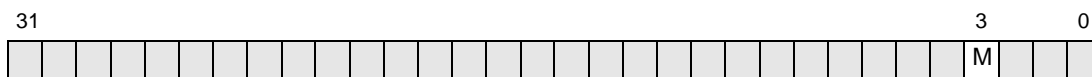

Bit	Description
3 -- I	Interrupt from the Outbound Post FIFO—the FIFO is not empty. This bit is continuously updated to reflect the status of the FIFO. It is Read-only; '0': no interrupt; '1': interrupt signalled. '0' default. Note: Unused bits in this register are read as 0s.

I₂O Host Interrupt Mask Register - I2OHIMR0x0034

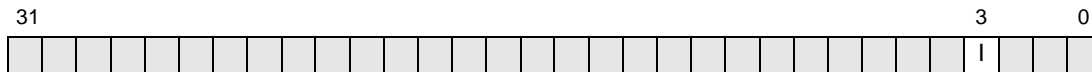
Bit	Description
3 -- M	Host Interrupt Mask Bit 1: interrupt is masked (default) 0: interrupt is not masked Note: Unused bits in this register are read as 1s.

I₂O Local Interrupt Status Register - I2OLISR0x0038

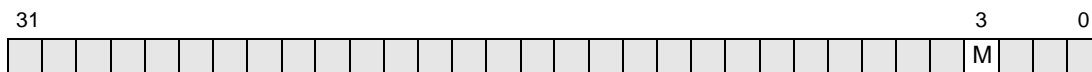
Bit	Description
3 -- I	Interrupt from the Inbound Post FIFO—the FIFO is not empty. This bit is continuously updated to reflect the status of the FIFO. It is Read-only; '0': no interrupt; '1': interrupt signalled. '0' default. Note: Unused bits in this register are read as 0s.

I₂O Local Interrupt Mask Register - I2OLIMR0x003C

Bit	Description
3 -- M	Local Interrupt Mask Bit 1: interrupt is masked (default) 0: interrupt is not masked Note: Unused bits in this register are read as 1s.

I₂O Inbound Free / Post FIFO – IBPFFIFO0x0040

 31 0

Inbound Free FIFO (read only) and Inbound Post FIFO (write only)

Bit	Description
31:0	A shared port -- Reading from this port returns data from the Inbound Free FIFO. The read of an empty FIFO returns 0xFFFF FFFF. Writing to this port places data into the Inbound Post FIFO. If the FIFO is already full, the contents of the FIFO will not change; the data written will be lost. The FIFO is initially empty. An asserted RST# empties all CY7C09449PV FIFO; all data will be lost.

I₂O Outbound Post / Free FIFO – OBPFFIFO0x0044

 31 0

Outbound Post FIFO (read only) and Outbound Free FIFO (write only)

Bit	Description
31:0	A shared port -- Reading from this port returns data from the Outbound Post FIFO. The read of an empty FIFO returns 0xFFFF FFFF. Writing to this port places data into the Outbound Free FIFO. If the FIFO is already full, the contents of the FIFO will not change; the data written will be lost. The FIFO is initially empty. An asserted RST# empties all CY7C09449PV FIFO; all data will be lost.

I₂O Inbound Post / Free FIFO – IBPFFIFO0x0048

 31 0

Inbound Post FIFO (read only) and Inbound Free FIFO (write only)

Bit	Description
31:0	A shared port -- Reading from this port returns data from the Inbound Post FIFO. The read of an empty FIFO returns 0xFFFF FFFF. Writing to this port places data into the Inbound Free FIFO. If the FIFO is already full, the contents of the FIFO will not change; the data written will be lost. The FIFO is initially empty. An asserted RST# empties all CY7C09449PV FIFO; all data will be lost.

I₂O Outbound Free / Post FIFO –OBPFFIFO0x004C

 31 0

Outbound Free FIFO (read only) and Outbound Post FIFO (write only)

Bit	Description
31:0	A shared port -- Reading from this port returns data from the Outbound Free FIFO. The read of an empty FIFO returns 0xFFFF FFFF. Writing to this port places data into the Outbound Post FIFO. If the FIFO is already full, the contents of the FIFO will not change; the data written will be lost. The FIFO is initially empty. An asserted RST# empties all CY7C09449PV FIFO; all data will be lost.

Direct Access Register
Direct Access Host Physical Base Address Register - DAHBASE0x0460

31	13	11	9	8	7	4	2	1	0
PCI Physical Base Address (4G byte, 8K byte blocks)			F	A1A0		Byte Enables for Reads	Type		

Bit	Description
31:13	PCI Physical Base Address specifying 8 Kbyte block
11 -- F	When '1', force contents of A1A0 to PCI during the PCI address phase.
9:8	Value to be placed on PCI bus, PCI A1 = bit 9, PCI A0 = bit 8.
7:4	Data Byte Enables for PCI Master Reads, C/BE#[3:0].
2:1 Type	PCI command cycle type for PCI Master Access 00 = interrupt acknowledge (read) (PCI command 0x0) or special cycle (write) (PCI command 0x1) 01 = I/O cycle (read or write) (PCI command 0x2 or 0x3) 10 = memory cycle (read or write) (PCI command 0x6 or 0x7) 11 = configuration cycle (read or write) (PCI command 0xA or 0xB)

I²C Serial Port Registers
I²C Serial Command Register -- NVCMD (a write only register)0x04A0

31	30	24	23	16	15	8	7	1	0
Device Address			Memory Address		Write Data			T	R

Bit	Description
30:24	Device Address. Device address of the I ² C serial device. Default is 1010000.
23:16	Memory Address. Address within the I ² C serial device.
15:8	Write Data. Write data. This data is ignored if the command is a read.
1 -- T	Read Type. This bit is ignored if the command is a write. The data read from a I ² C serial device is accessible from the NVREAD register. 1 = 4-byte read 0 = single-byte read
0 -- R	Read / Write 1 = read command 0 = write command Note: The write of this byte triggers the start of the EEPROM access. In an 8- or 16-bit system, this location must be written after the address and data have been written.

I²C Serial Read Data Register -- NVREAD0x04A4

This register contains one or four bytes of data read from the I²C serial EEPROM.

31	24 23	16 15	8 7	0
Byte 3		Byte 2		Byte 0

Bit	Description
31:24 Byte 3	Stores sequential read, byte 3. Undefined for single byte read.
23:16 Byte 2	Stores sequential read, byte 2. Undefined for single byte read.
15:8 Byte 1	Stores sequential read, byte 1. Undefined for single byte read.
7:0 Byte 0	Stores single read and sequential read, byte 0.

I²C Serial Status Register – NVSTAT0x04A8

This register contains status information about the I²C serial data transfer.

31	8 7 5 4	0
		ACK
		D

Bit	Description
7:5 -- ACK	Acknowledge bit 7 = device address ack bit. 0 = ack, 1 = no ack. bit 6 = address ack bit. 0 = ack, 1 = no ack. bit 5 = second address ack bit. 0 = ack, 1 = no ack. In a successful read or write, these bits will be 000.
0 -- D	Done Indicator 1 = done 0 = in progress

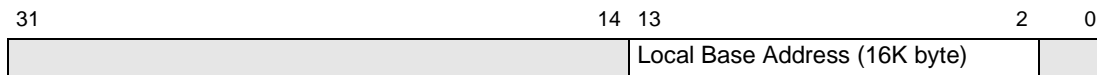
PCI Bus Mastering (DMA) Registers
DMA Local Base Address Register – DMALBASE0x04B0

Bit	Description
13:2	Local Base Address - This is the first address of the DMA in the local memory. This register has DWORD resolution.

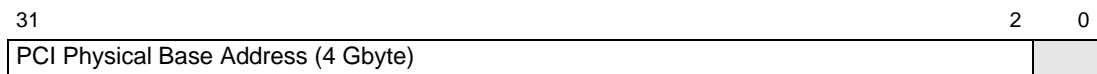
DMA Host Physical Base Address Register – DMAHBASE0x04B4

Bit	Description
31:2	PCI Physical Base Address - This is the first address of the DMA in the host's memory space. This register has DWORD resolution.

DMA Size Register – DMASIZE
0x04B8

Bit	Description
13:2	Burst Size for any mastered DMA, read or write. This register has DWORD resolution.

DMA Control Register – DMACTL0x04BC

Bit	Description
9 -- L	Local Ownership: Writing to this bit by the local processor will update the value if and only if the P bit is not set to '1.' A write to this bit from the PCI bus will never update this bit. This bit (along with the P bit) is intended to facilitate software arbitration of the DMA registers. '0' default.
8 -- P	PCI Ownership: Writing to this bit by the PCI bus will update the value if and only if the L bit is not set to '1'. A write to this bit from the local processor will never update this bit. This bit (along with the L bit) is intended to facilitate software arbitration of the DMA registers. '0' default.
1 -- PI	Pre-Fetch Inhibit for PCI memory reads: When this bit is set to one, the CY7C09449PV PCI bus master engine will only use the PCI Read command (0x6). When this bit is zero (default), the CY7C09449PV PCI bus master engine will use PCI commands Read (0x6), Read Line (0xC), and Read Multiple (0xE) as appropriate to optimize utilization of the PCI system bus(es).
0 -- W	Write: Determines the direction of the DMA and starts transfer. 1: DMA operation is a write to the PCI bus memory from the CY7C09449PV shared memory. 0: DMA operation is a read from the PCI bus memory into the CY7C09449PV shared memory. A write to the low byte of this register triggers the DMA to occur. '0' default.

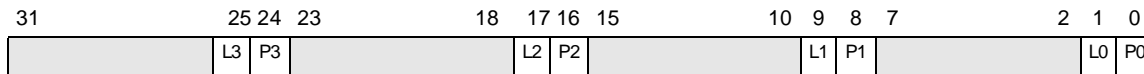
Arbitration Utility Flag Register – ARB_FLAGS0x04C0

Bit	Description
25 -- L3	L3 Ownership: A write to this bit by the local processor will update this bit if and only if the P3 bit is not set to '1'. '0' default.
24 -- P3	P3 Ownership: A write to this bit by the PCI bus will update this bit if and only if the L3 bit is not set. '0' default.
17 -- L2	L2 Ownership: A write to this bit by the local processor will update this bit if and only if the P2 bit is not set to '1'. '0' default.
16 --P2	P2 Ownership: A write to this bit by the PCI bus will update this bit if and only if the L2 bit is not set. '0' default.
9 -- L1	L1 Ownership: A write to this bit by the local processor will update this bit if and only if the P1 bit is not set to '1'. '0' default.
8 -- P1	P1 Ownership: A write to this bit by the PCI bus will update this bit if and only if the L1 bit is not set. '0' default.
1 -- L0	L0 Ownership: A write to this bit by the local processor will update this bit if and only if the P0 bit is not set to '1'. '0' default.
0 -- P0	P0 Ownership: A write to this bit by the PCI bus will update this bit if and only if the L0 bit is not set. '0' default.

Host Control and Status Registers
Host Control Register – HCTL0x04E0

Bit	Description
1 -- S	Soft Reset – This bit controls the internal reset for the CY7C09449PV. 1 = reset active 0 = not reset (default)
0 -- R	Local Processor Reset – This bit controls the $\overline{\text{RSTOUTD}}$ and RSTOUTD pins. 1 = reset active (default state, $\overline{\text{RSTOUTD}}$ pin is LOW, RSTOUTD pin is HIGH) 0 = not reset (RSTOUTD pin is HIGH, $\overline{\text{RSTOUTD}}$ pin is LOW)

This register contains two types of reset bits. The Local Processor Reset bit, R, is intended for use by circuitry connected to the CY7C09449 local bus. The output signals $\overline{\text{RSTOUTD}}$ and RSTOUTD are a direct reflection of the state of this bit. It is intended that $\overline{\text{RSTOUTD}}$ (or its active low version RSTOUTD) be connected to the local processor system's reset. R is set to '1' when the CY7C09449PV reset input is asserted ($\text{RST} = '0'$). After deassertion of $\overline{\text{RST}}$, R will remain set to '1' until the CY7C09449PV Auto-Configuration process has completed and it has been cleared either via the Auto-Configuration termination control setting or via the PCI bus interface. If RSTOUTD is not used as the local processor system reset, then it can also be cleared via the Local bus interface.

The second reset bit is the Soft Reset bit, S. This is used to reset certain internal registers and states of the CY7C09449PV. It is primarily intended for test and debug op-

erations during product development. When S = '1,' it will reset all of the Operations Registers according to their reset default values with the following exceptions:

- DMACTL (at offset 0x04BC): All bits are reset to '0', except bits PL and W remain unchanged
- HINT (at offset 0x04E4): All bits remain unchanged
- LINT (at offset 0x04F4): Bit 3 (Host to Local Mailbox) is cleared to '0', all other bits remain unchanged
- LBUSCFG (at offset 0x04FC): All bits remain unchanged

Additional behavior when S = '1' is as follows:

- DQ[31:00] is held at high impedance;
- Local bus state machine is held in idle;
- DMA state machine is held in idle;
- PCI bus state machine mastering access is held in idle; and
- FIFO are emptied and flags return to default (empty).

Host Interrupt Control and Status Register – HINT0x04E4

31	25 24	16 15	10 9	0
Interrupt Enable			Interrupt Status	

Bit	Description
25:16 Interrupt Enable	Interrupt Enables 0000000000 =no interrupts are enabled (default) xxxxxxxx1 =I ₂ O Local FIFO overflow interrupt enabled xxxxxxxx1x =I ₂ O PCI FIFO overflow interrupt enabled xxxxxxxx1xx =reserved - always read as 0 xxxxxx1xxx =Local to host, mailbox interrupt enabled xxxxx1xxxx =Local to host, external signal interrupt enabled xxxx1xxxxx =DMA complete interrupt enabled xxx1xxxxxx =I ₂ O inbound post FIFO not empty interrupt enabled xx1xxxxxxx =I ₂ O outbound post FIFO not empty interrupt enabled x1xxxxxxx =PCI target abort interrupt enabled 1xxxxxxx =PCI master abort interrupt enabled Note: All enable bits are initially cleared.
9:0 Interrupt Status	Interrupt Event Status 0000000000 = no events active xxxxxxxx1 =I ₂ O Local FIFO overflow xxxxxxxx1x =I ₂ O PCI FIFO overflow xxxxxxxx1xx =reserved - always read as 0 xxxxxx1xxx =Local to host mailbox xxxxx1xxxx =Local to host external signal interrupt xxxx1xxxxx =DMA complete xxx1xxxxxx =I ₂ O inbound post FIFO not empty (mirror of I2OLISR[3] - read only at this address) xx1xxxxxxx = I ₂ O outbound post FIFO not empty (mirror of I2OHISR[3] - read only at this address) x1xxxxxxx = PCI target abort 1xxxxxxx = PCI master abort Note: When an event status bit is active, writing a '1' to that bit location will clear the bit except for bits 6 and 7. All event status bits are initially cleared.

Host to Local Data Mailbox – HLDATA0x04E8

31	25 24 23	16 15	8 7	0
	I	Byte 1	Byte 0	

Bit	Description
24 -- I	Interrupt to Local This bit enables the host to send an interrupt to the Local. When it is set to 1 by the host, it triggers a mailbox interrupt to the local processor. The interrupt remains active until it is cleared by writing to the Local Interrupt Control and Status Register - LINT. 0 = inactive 1 = active This bit is write only.
15:8 -- Byte 1 7:0 -- Byte 0	Data byte Two bytes of data that can be written by the host and read by the local processor.

Local Control and Status Registers
Local Interrupt Control and Status Register – LINT0x04F4

31	25 24	16 15	10 9	0
	Interrupt Enable		Interrupt Status	

Bit	Description
25:16 Interrupt Enable	Interrupt Enables 0000000000 = no interrupts are enabled (default) xxxxxx xxx1 = I ₂ O Local FIFO overflow interrupt enabled xx xxxx xx1x = I ₂ O PCI FIFO overflow interrupt enabled xx xxxx x1xx = reserved - always read as 0 xx xxxx 1xxx = Host to Local mailbox interrupt enabled xx xxx1 xxxx = reserved - always read as 0 xx xx1x xxxx = DMA complete interrupt enabled xx x1xx xxxx = I ₂ O inbound post FIFO not empty interrupt enabled xx 1xxx xxxx = I ₂ O outbound post FIFO not empty interrupt enabled x1 xxxx xxxx = PCI target abort interrupt enabled 1x xxxx xxxx = PCI master abort interrupt enabled Note: All enable bits are initially cleared.
9:0 Interrupt Status	Interrupt Event Status 00 0000 0000 = no events active xx xxxx xxx1 = I ₂ O Local FIFO overflow xx xxxx xx1x = I ₂ O PCI FIFO overflow xx xxxx x1xx = reserved - always read as 0 xx xxxx 1xxx = Host to Local mailbox xx xxx1 xxxx = reserved - always read as 0 xx xx1x xxxx = DMA operation complete xx x1xx xxxx = I ₂ O inbound post FIFO not empty (mirror of I2OLISR[3] - read only at this address) xx 1xxx xxxx = I ₂ O outbound post FIFO not empty (mirror of I2OHISR[3] - read only at this address) x1 xxxx xxxx = PCI target abort 1x xxxx xxxx = PCI master abort Note: When an event status bit is active, writing a '1' to that bit location will clear the bit except for bits 6 and 7. All event status bits are initially cleared.

Local to Host Data Mailbox – LHDATA0x04F8

31	25 24 23	16 15	8 7	0
I		Byte 1	Byte 0	

Bit	Description
24 -- I	Interrupt to Host When this bit is written to 1 by the local processor, it causes a mailbox interrupt to the host. The interrupt will remain active until it is cleared by the host in the Host Interrupt Control and Status Register - HINT 0 = inactive 1 = active This bit is write only.
15:8 -- Byte 1 7:0 -- Byte 0	Data bytes Two bytes of data written by the local and read by the host processor.

Local Bus Configuration Register – LBUSCFG0x04FC

31	21 20	0
Local Bus Configuration		

Bit	Description
20	LINE_WRAP_DIS: Defines the enable for cache line wrapping. 0 = Enable cache line wrapping (default) 1 = Disable cache line wrapping
19	RDY_IN_FALL: Defines the edge of CLKIN used to sample the RDY_IN and $\overline{\text{RDY_IN}}$ input signals. 0 = Rising Edge (default) 1 = Falling Edge
18	SELECT_POL: Defines the polarity of the $\overline{\text{SELECT}}$ input signal. 0 = Active LOW (default) 1 = Active HIGH
17	SELECT_FALL: Defines the edge of CLKIN used to sample the $\overline{\text{SELECT}}$ input signal. 0 = Rising Edge (default) 1 = Falling Edge
16	RDY_OUT_OE: Defines the three-state mode of the $\overline{\text{RDY_OUT}}$ output signal. 0 = Drive all of the time. 1 = Drive only when asserted active. (default)
15	XTND_RDY_OUT: Defines the $\overline{\text{RDY_OUT}}$ output signal relation to the final data phase. 0 = Normal. RDY_OUT goes inactive after the final data phase (default) 1 = Extended Ready Out. RDY_OUT remains active after the final data phase until the internal address strobe (typically STROBE) goes inactive. (see field RWMODE for the defining characteristics of the Internal Address Strobe). -- DO NOT set XTND_RDY_OUT = 1 when BLASTMODE = 1.
14	BURST_STYLE: Defines the data ordering protocol of bursts on the local bus. 0 = normal linear bursts (default) 1 = 486 style burst (byte ordering in a burst is 048C; 40C8; 8C04; C840)
13	INT_POL: Defines the polarity of the $\overline{\text{IRQ_OUT}}$ output signal. 0 = Active LOW interrupt to the local processor (default) 1 = Active HIGH interrupt to the local processor
12	BLAST_POL: Defines the polarity of the $\overline{\text{BLAST}}$ input signal. 0 = Active LOW (default) 1 = Active HIGH
11	ALE_POL: Defines the polarity of the ALE input signal. 0 = Active LOW 1 = Active HIGH (default)
10	RDYOUT_POL: Defines the polarity of the $\overline{\text{RDY_OUT}}$ output signal. 0 = Active LOW (default) 1 = Active HIGH
9:8	BW: Defines the data bus width of the local processor interface. 00 = 8 bit 10 = 32 bit 01 = 16 bit 11 = 32 bit with encoded byte enables per Motorola protocol (default)
7	BLASTMODE: Determines the function of the $\overline{\text{BLAST}}$ input signal. 0 = $\overline{\text{BLAST}}$ is active only during the last transaction of the burst (default) 1 = $\overline{\text{BLAST}}$ is active throughout the entire burst, and goes inactive when with $\overline{\text{RDY_IN}}$ or RDY_IN become inactive on the last read or write of the burst. -- DO NOT set BLASTMODE = 1 when XTND_RDY_OUT = 1.
6	BEMODE: Determines the byte enable encoding for 16 and 32 bit Motorola modes. 0 = normal byte enables 1 = Motorola byte enable encoding. (default)

Bit	Description			
5:4	RWMODE: Defines how the $\overline{\text{READ}}$, $\overline{\text{WRITE}}$, and address $\overline{\text{STROBE}}$ input signals are interpreted internally and defines the Internal Address Strobe. The active polarity of $\overline{\text{STROBE}}$ is determined by $\overline{\text{ASMODE}}$. '01' is default.			
	Pin Name	RWMODE = 00	RWMODE = 01	RWMODE = 1X
	$\overline{\text{READ}}$	$\overline{\text{W_R}}$	Not Used	$\overline{\text{READ}}$ data; used as Internal Strobe
	$\overline{\text{WRITE}}$	Not Used	$\overline{\text{R_W}}$	$\overline{\text{WRITE}}$ data; used as Internal Strobe
	$\overline{\text{STROBE}}$	Internal Address Strobe	Internal Address Strobe	Not used as Internal Address Strobe
3:2	ASMODE: Bit 2 defines the polarity of $\overline{\text{STROBE}}$ input signal. And bit 3 defines the edge of $\overline{\text{CLKIN}}$ used to sample the Internal Address Strobe (see field $\overline{\text{RWMODE}}$ for a defining characteristic of the Internal Address Strobe) x0 = $\overline{\text{STROBE}}$ is active LOW (default)x1 = $\overline{\text{STROBE}}$ is active HIGH 0x = Internal Address Strobe rising edge sampled (default)1x = Internal Address Strobe falling edge sampled			
1	DDIN: Delayed Data Input -- Defines protocol for validated input data. 0 = input data is valid during the current cycle when $\overline{\text{RDY_IN}}$, $\overline{\text{RDY_IN}}$, and $\overline{\text{RDY_OUT}}$ are active. (default) 1 = input data is valid one cycle after when $\overline{\text{RDY_IN}}$, $\overline{\text{RDY_IN}}$, and $\overline{\text{RDY_OUT}}$ are active.			
0	DDOUT: Delayed Data Output -- Defines protocol for validated output data. 0 = output data is valid during current cycle when $\overline{\text{RDY_IN}}$, $\overline{\text{RDY_IN}}$, and $\overline{\text{RDY_OUT}}$ are active. (default) 1 = output data is valid one cycle after when $\overline{\text{RDY_IN}}$, $\overline{\text{RDY_IN}}$, and $\overline{\text{RDY_OUT}}$ are active.			

Performance Characteristics
Absolute Maximum Ratings ^[4]

Storage Temperature	-55°C to +125°C
Ambient Temperature Under Bias	-40°C to +85°C
Max Operating Current (I_{DD}) ^[5,6]	250 mA
Voltage on Any V_{DD} Pin Referenced to V_{SS} ..	-0.5V to +4.0V
Voltage on Any Signal Pin Referenced to V_{SS} ..	-0.5V to +7.0V

Recommended Operating Environment

Ambient Operating Temperature	T_A 0°C to +70°C
Supply Voltage	V_{DD} +3.0V to +3.6V
Ground Voltage Reference	V_{SS} 0.0V
F_{CLK} (PCI Clock Input Frequency)	CLK0 MHz to 33 MHz
F_{CLKIN} (Local Bus Clock Input Frequency) ^[7]	CLKIN0 MHz to 50 MHz

Recommended Operating DC Parameters—PCI Bus Signals

The CY7C09449PV is compatible with the PCI requirements for 3.3V and 5V signaling. Refer to the PCI Local Bus Specification, Revision 2.2, as published by the PCI Special Interest Group; the URL is <http://www.pcisig.com/>

Due to the 5V tolerant nature of the I/O, the I/O are not clamped to VDD. Operation of the CY7C09449PV in a PCI 5V signaling environment is electrical and timing compatible with the PCI specification. In a 3.3V signaling environment, all PCI requirements are met except for the output 3.3V clamp, which is in direct conflict with 5V tolerance. The CY7C09449PV complies with the PCI AC specifications.

Parameter	Description	Condition	Min.	Max.	Unit
V_{IH}	Input High Voltage		$0.5V_{DD}$	+5.75V	V
V_{IL}	Input Low Voltage		-0.5	$0.3V_{DD}$	V
V_{IPU}	Input Pull-up Voltage		$0.7V_{DD}$		V
I_{IL}	Input Leakage Current	$0 < V_{IN} < V_{DD}$		±10	µA
V_{OH}	Output High Voltage ^[8]	$I_{OUT} = -0.5$ mA	$0.9V_{DD}$		V
V_{OL}	Output Low Voltage	$I_{OUT} = 1.5$ mA		$0.1V_{DD}$	V
C_{IN}	Input Pin Capacitance			10	pF
C_{CLK}	CLK Pin Capacitance		5	12	pF
C_{IDSEL}	IDSEL Input Pin Capacitance			8	pF
L_{PIN}	Pin Inductance			20	nH

Recommended Operating DC Parameters—Local Signals

The recommended operating DC parameters for the local bus are specified here.

Parameter	Description	Condition	Min.	Max.	Unit	Notes
V_{IH}	Input High Voltage		2.0	5.75	V	
V_{IL}	Input Low Voltage		-0.5	0.8	V	
I_{IL}	Input Leakage Current	$0 < V_{IN} < V_{DD}$		±10	µA	
V_{OH}	Output High Voltage	$I_{OUT} = -0.8$ mA	2.4		V	8
V_{OL}	Output Low Voltage	$I_{OUT} = 0.8$ mA		0.5	V	
C_{IN}	Input Pin Capacitance			10	pF	
C_{CLK}	CLK Pin Capacitance		5	12	pF	
L_{PIN}	Pin Inductance			20	nH	

Notes:

- The voltage on any input or I/O pin can not exceed the power pin during power-up.
- CLK=33 MHz, CLKIN = 50 MHz, PCI and Local buses operating at 25% duty cycle.
- Also see Operating Power Characteristics section (Page 45).
- For proper initialization, CLKIN must toggle more than 300,000 cycles after \overline{RST} has been deasserted.
- Except that INTA is an open drain output.
- Except that IRQ_OUT is an open drain output.

Timing Parameters—PCI Bus Signals

The CY7C09449PV is compliant with the PCI timing requirements for 3.3V and 5V signaling. Refer to the PCI Local Bus Specification, Revision 2.2, as published by the PCI Special Interest Group; the URL is <http://www.pcisig.com/>

Parameter	Description	Min.	Max.	Unit
t_{CYC}	CLK Cycle Time ^[10]	30		ns
t_{HIGH}	CLK High Time	11		ns
t_{LOW}	CLK Low Time	11		ns
	CLK Slew Rate	1	4	V/ns
t_{VAL}	CLK to Output for Bused Signals ^[11]	2	11	ns
$t_{VAL(REQ)}$	CLK to Output for \overline{REQ} ^[11]	2	12	ns
t_{ON}	Float to Active Delay from CLK	2		ns
t_{OFF}	Active to Float Delay from CLK		28	ns
t_{SU}	Input Set-up Time to CLK for Bused Signals	7		ns
$t_{SU(GNT)}$	Input Set-up Time to CLK for \overline{GNT}	10		ns
t_{HOLD}	Input Hold Time to CLK	0		ns
	\overline{RST} Slew Rate ^[12]	50		mV/ns
t_{RST}	\overline{RST} Active Time after Power Stable	1		ms
$t_{RST-CLK}$	\overline{RST} Active Time after CLK Stable ^[13]	100		μ s
$t_{RST-OFF}$	\overline{RST} Active to Output Float Delay		40	ns
$t_{RST-FPCA}$	\overline{RST} High to First PCI Configuration Access	2^{25}		clocks
$t_{RHI-FFA}$	\overline{RST} High to First \overline{FRAME} Assertion	5		clocks

Timing Parameters—CY7C09449PV Buffered PCI Clock and Reset

The CY7C09449PV provides copies of the PCI clock input, CLK, on the PCLKOUT[2:0] pins. The system level function and timing of these outputs are the same as those of the CLK input. The CY7C09449PV also provides a registered copy of the PCI reset input, \overline{RST} , on the RSTOUT pin. The PCI reset is synchronized to the Local bus clock, CLKIN. RSTOUT will follow \overline{RST} by no more than two CLKIN cycles. The detailed timing characteristics of the PCLKOUT[2:0] and RSTOUT signal outputs is shown below.

Parameter	Description	Min.	Max.	Units
$t_{PCLKOUT}$	PCLKOUT Delay from CLK ^[14]	2	10	ns
t_{RSTOUT}	CLKIN to \overline{RSTOUT} Valid ^[14]	2	10	ns

Notes:

10. Clock frequency may range from nominal DC to 33 MHz. The clock frequency may change at anytime, but must not violate other parameters of this specification: clock edges must remain monotonic and within the specified CLK Slew Rate and clock high and low times must be no shorter than specified CLK High and CLK Low Times.
11. Output maximum times are evaluated with $C_L = 50$ pF. Output minimum times are evaluated with $C_L = 0$ pF. Actual test capacitance may vary, but results are correlated to these loads.
12. Specification only applies to rising (deasserted) edge of \overline{RST} .
13. \overline{RST} is asserted and deasserted asynchronously to CLK.
14. 50-pF load.

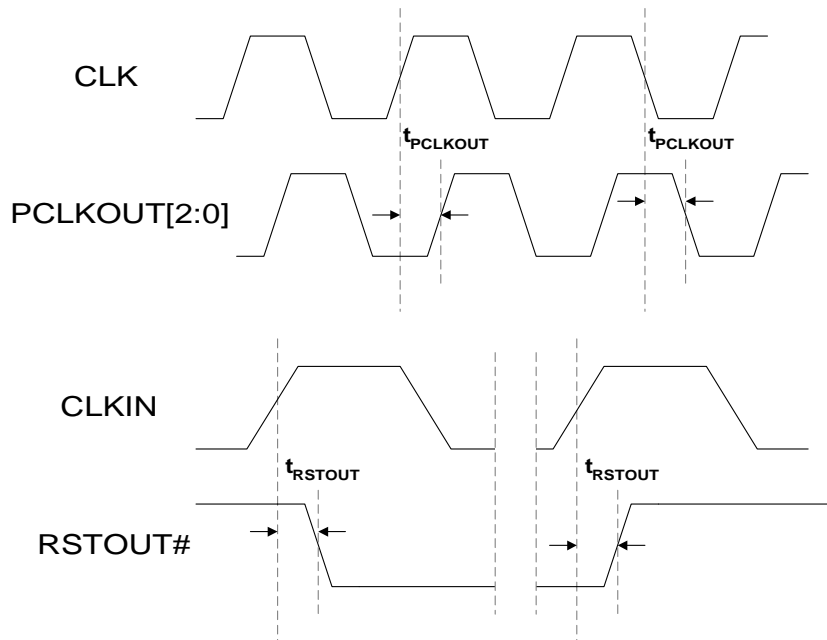

Timing Parameters — Local Bus Signals

The parameters for the local bus are specified here.

Parameter	Description	Min.	Max.	Unit
t_{LOCAL}	CLKIN Cycle Time (Local clock) ^[15]	20		ns
t_{HIGH}	CLKIN High Time ^[16]	40	60	%
t_{LOW}	CLKIN Low Time ^[16]	40	60	%
t_{SU}	Input Set-up Time to CLKIN ^[17]	8		ns
t_{HOLD}	Input Hold Time to CLKIN	3		ns
t_{OUT}	CLKIN to Output Valid ^[18]	2	10	ns
t_{ON_DQ}	DQ[31:0] Float to Active Delay from CLKIN	2	14	ns
t_{OUT_DQ}	DQ[31:0] Output Delay from CLKIN	2	10	ns
t_{OFF_DQ}	DQ[31:0] Active to Float Delay from CLKIN	2	14	ns
t_{SU_ADR}	ADR[14:2] Input Set-up Time to CLKIN	6		
t_{H_ADR}	ADR[14:2] Input Hold Time from CLKIN	3		ns
t_{SU_ALE}	ADR[14:2] Input Set-up Time to ALE	1		
t_{H_ALE}	ADR[14:2] Input Hold Time from ALE	3		ns
t_{MIN_ALE}	Minimum Active Pulse width for ALE ^[19]	5		ns

Notes:

15. $V_{TEST} = 1.5V$.
16. Voltage threshold for HIGH is 2.0V; Voltage threshold for LOW is 0.8V.
17. Inputs are STROBE, SELECT_READ_WRITE, RDY_IN, RDY_IN_BE[3:0], DQ[31:0], BLAST, and $\overline{IRQ_IN}$.
18. $C_L = 50$ pF. Outputs are RDY_OUT, IRQ_OUT, RSTOUTD, and RSTOUTD.
19. Voltage threshold for HIGH is 2.0V.

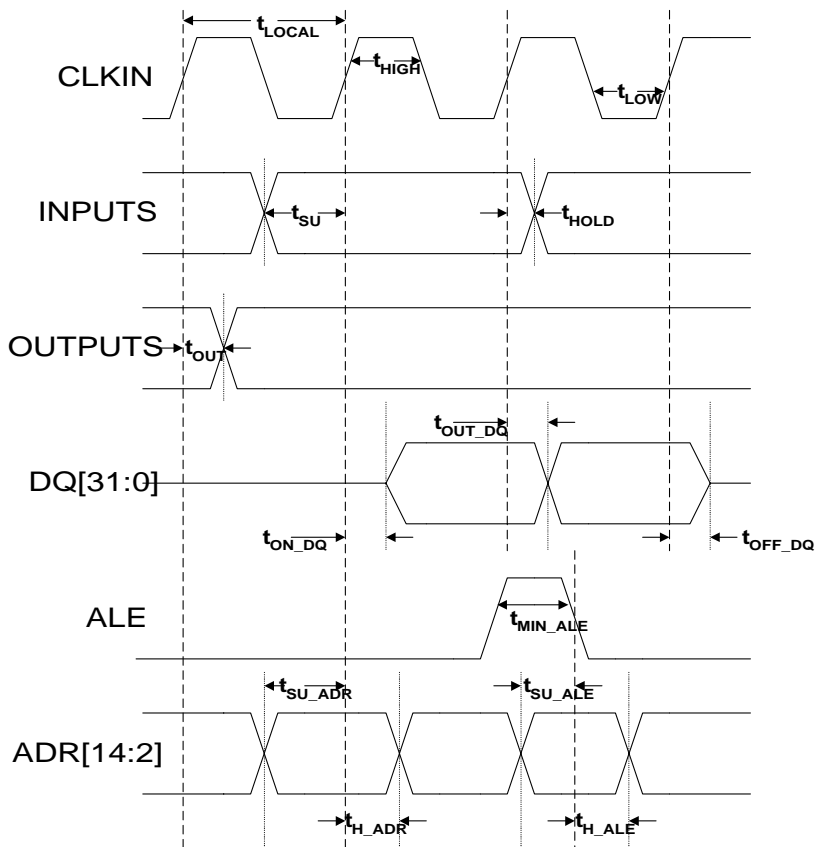

Timing Parameters—I²C Serial Port Bus Signals

The I²C-compatible serial interface is designed for a 100-Kb transfer rate. The interface clock is referenced to the local clock, CLKIN. The table below gives the parameters of the CY7C09449PV's I²C-compatible serial interface with respect to the number of local clock periods and the equivalent number of microseconds if the clock is run at 50 MHz. The 100-Kbit/s rate is accomplished with a CLKIN rate of 50 MHz. For CLKIN rates other than 50 MHz, use the Minimum Clocks column to calculate the Minimum Time for each parameter.

Parameter	Description	Minimum Clocks (Clock Periods)	Minimum Time (microseconds)
t_{SCL_LO}	Low Period of SCL	250	5.00
t_{SCL_HI}	High Period of SCL	250	5.00
t_{BUF}	Bus Free Time between 'Start' & 'Stop' ^[20, 21]	500	10.00
t_{SU_STA}	Set-up Time for Repeated 'Start' ^[20]	250	5.00
t_{HD_STA}	Hold Time for 'Start'	250	5.00
t_{SU_DAT}	Set-up Time for Data	125	2.50
t_{HD_DAT}	Hold Time for Data	125	5.00
t_{SU_STO}	Set-up time for 'Stop'	250	5.00

Notes:

- 20. 'Start' condition is a HIGH-to-LOW transition on SDA while SCL is HIGH.
- 21. 'Stop' condition is a LOW-to-HIGH transition on SDA while SCL is HIGH.

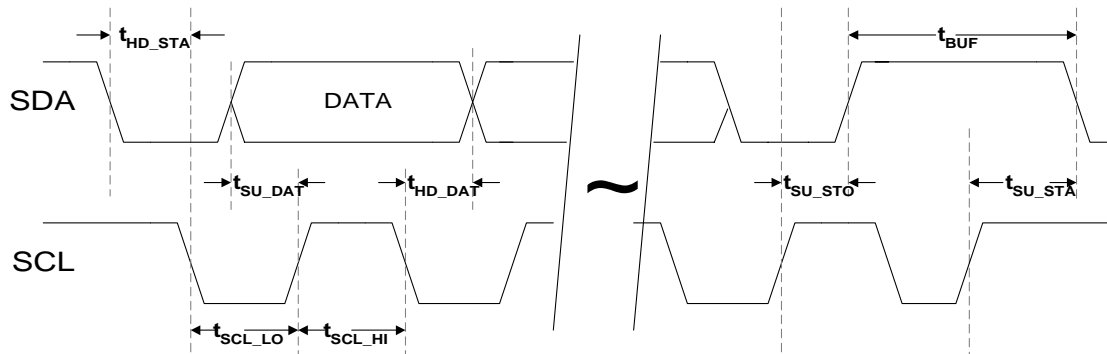

Operating Power Characteristics

Operating power and currents for the CY7C09449PV at typical environment are specified here, $V_{DD} = +3.3V$, Temp. = $+25^{\circ}C$.

Parameter	Description	Condition	Max.	Unit
PD	Power Dissipation ^[22]		720	mW
I_{DD}	Operating Current ^[22]		200	mA
$I_{DD_LSTATIC}$	Static Local Bus Clock ^[23]		40	mA
I_{DD_STATIC}	Static, no clocks		1	mA

Notes:

22. CLK = 33 MHz, CLKIN = 50 MHz, PCI and Local buses operating at 25% duty cycle. This value is typical.
23. CLK = 33 MHz, CLKIN = 0 MHz, PCI and Local buses are inactive. Note that for proper initialization of the CY7C09449PV, CLKIN must toggle for some number of cycles after RST# is de-asserted. See the section Recommended Operating Environment for the specification of the CLKIN toggle parameter.

CY7C09449PV Operations

Local Bus Configurations

The CY7C09449PV interfaces to several processor families. Local bus configurations words for some processors are indicated here. These may not be suitable for all applications for a given processor. The specific application's local processor subsystem architecture may impact some parameters of the local bus configuration word. The 21-bit Local Bus Configuration Operations register, LBUSCFG, can be written via the I²C serial interface upon chip initialization to prepare the CY7C09449PV local bus for the proper interface protocol.

<u>Processor</u>	<u>LBUSCFG value</u>
Motorola Power QUICC MPC860 (default)	0x010B50
Motorola QUICC 68360	0x018B18
Motorola 68040 (default)	0x010B50
Intel i960	0x010A00
Intel i486	0x016A00
Intel 80186	0x012D21
Hitachi SH7708	0x010E11
Hitachi H8/3048	0x010D00
Texas Instruments TMS320LC31	0x010A91

PCI Bus Mastering

Burst transfers between the CY7C09449PV 16-KB shared memory and the PCI bus system are performed by the direct memory access (DMA) controller. Set-up for the DMA controller is accomplished by programming the Operations Registers of the CY7C09449PV from either the PCI bus interface or the Local bus interface. An indication of a completed DMA is available by polling an Operations register or servicing an interrupt. Ownership of the DMA controller by either the PCI or Local bus interfaces is arbitrated by software using the Operations Registers.

The address and transfer size registers operate with DWORD resolution. The lower two bits of each of the address and transfer size fields are ignored. Transfers over the PCI bus are DWORD so all four byte enables of the bus are active when transferring data mastered by the CY7C09449PV. The full 32-bit PCI address space is supported by the DMA controller. The direction of transfer is determined by the 'W' bit in the DMA Control Register. 'W' is the "Write" bit and is with respect to the CY7C09449PV "writing" to the PCI bus. The basic sequence to setup a DMA is as follows:

1. Enable the Interrupt Mask for the desired interface if an interrupt on DMA completion is required (e.g., LINT[21] = 1 will enable the interrupt onto the IRQ_OUT pin).
2. Load the address for the beginning of the transfer block of CY7C09449PV shared memory. This is the DMA Local Base Address Register, DMALBASE.
3. Load the address for the beginning of the transfer block of PCI bus space. This is the DMA Host Base Address Register, DMAHBASE.
4. Load the size of the transfer block. This is the DMA Size Register, DMASIZE.
5. To initiate the DMA, a write to the least significant byte of the DMA Control Register, DMACTL, will start the controller.

Writing a '1' to bit 0 will transfer data from the CY7C09449PV shared memory, (pointed to by DMALBASE), to the PCI bus space, (pointed to by DMAHBASE). This causes write bursts on the PCI bus. Writing a '0' to bit 0 will transfer the other direction and cause read bursts on the PCI bus. The CY7C09449PV bus mastering logic will use the most efficient PCI command available for all of its bursts during the transfer.

6. When the DMA is complete, LINT[5] will be set. If interrupts are enabled for DMA completions, then an interrupt will be generated. If not, LINT[5] can be polled.

An additional option of a PCI bus mastered read transfer involves setting the option to perform non-prefetchable PCI reads during transfers into CY7C09449PV shared memory. This option is set in the DMA Control Register with the PFI flag. Also, ownership of the controller can be arbitrated in software with assistance of the L and P bits in the DMA Control Register; these are the Local Bus Ownership and PCI Bus Ownership flags, respectively. See the section CY7C09449PV Operations Registers for details.

I₂O Message Unit

The I₂O Specification describes a messaging unit consisting of four FIFOs, a shared memory to store message frames, and an interrupt function. The structure of this unit is described in the I₂O Architecture Specification, version 1.5 on pages 4-2 through 4-7. This capability is fully integrated within the CY7C09449PV. Reference URL: <http://www.i2osig.org/>

There is no need for external circuitry to manage the FIFO operations. If I₂O functionality is not desired, then the FIFOs are available for general purpose use. Each of the four FIFO are 32 DWORD deep, are accessible from both the PCI and Local bus interfaces, and can generate interrupts to both bus interfaces.

The unit operates in two clock domains, that of the PCI bus and that of the Local bus. I₂O message frames for transfer between the PCI and the Local domains are located within the 16-Kbyte CY7C09449PV Shared Memory, which is a general-purpose dual-port memory. There is no restriction upon where in the 16-Kbyte space that the message frames reside, however, to satisfy I₂O requirements, the message frames must begin at DWORD boundaries. Neither bus's access is dependent upon the operational state of the other bus. This is governed by the nature of the CY7C09449PV Shared Memory. Operations of the I₂O FIFO and the I₂O Interrupt functions occur completely within the clock domain of the Local bus, however access is available to both the PCI and Local bus interfaces.

From a system perspective, the following diagram illustrates the I₂O Message Unit transfer function supported by the CY7C09449PV. The CY7C09449PV is represented by the "Message Queues" block of the diagram and consists of both Inbound and Outbound Queues and the Shared Memory. For more description of the terminology used in the diagram, refer to the I₂O Architecture Specification. Reference URL: <http://www.i2osig.org/>

Direct Access

Direct Access allows the local processor to access the PCI bus directly, bypassing the shared memory. In this mode the local processor can generate the following PCI bus master cycles:

- Configuration Read $C/\overline{BE}[3:0] = 0xA$

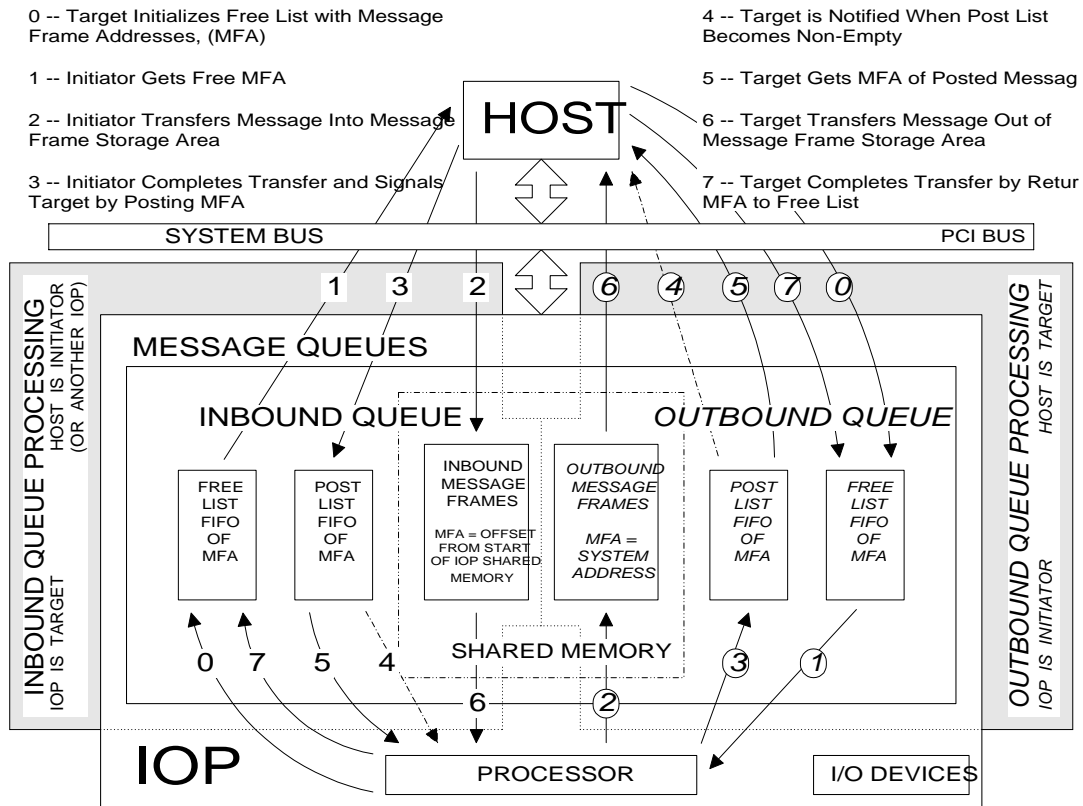

QUEUES.VSD DB 7/15/9

- Configuration Write $C/\overline{BE}[3:0] = 0xB$
- I/O Read $C/\overline{BE}[3:0] = 0x2$
- I/O Write $C/\overline{BE}[3:0] = 0x3$
- Memory Read $C/\overline{BE}[3:0] = 0x6$
- Memory Write $C/\overline{BE}[3:0] = 0x7$
- Special Cycle $C/\overline{BE}[3:0] = 0x1$
- Interrupt Acknowledge $C/\overline{BE}[3:0] = 0x0$

To operate in this mode, the local processor programs the Direct Access register. Programming sets the base address for the PCI master access and the type of PCI command to be generated. Then the local processor writes to the Direct Access space of the CY7C09449PV Memory Map. Offsets into the Direct Access region of the memory map are added to the PCI base address of the Direct Access register and become the address for the PCI bus master access. The type of PCI command generated is defined in the Direct Access register. A local bus read to the Direct Access area of the memory map becomes a PCI bus master read. Likewise, a local bus write to the memory map becomes a PCI bus master write.

Host Bridge

The CY7C09449PV can be used as a host bridge. The processor on the CY7C09449PV Local bus is therefore the host processor in the system. A host processor configures the other PCI devices on the PCI bus. The CY7C09449PV provides the I²C Serial Port and Auto-Configuration mechanism to setup for host bridge operations. Most aspects of Auto-Configuration apply to non-host use of the CY7C09449PV, as well.

The CY7C09449PV must master cycles onto the PCI bus to be a host bridge. The Master Enable bit located in the PCI

configuration space is the means to enable CY7C09449PV PCI mastering. Since the CY7C09449PV's default value for the Master Enable bit is deasserted, it is necessary to use the CY7C09449PV Auto-Configuration mechanism to enable PCI mastering. During the power-up reset sequence, the I²C serial interface loads data from a non-volatile memory (typically a serial EEPROM) to set the Master Enable bit in the PCI configuration space. Some, but not all, of the PCI configuration values are loaded using this mechanism. These values can be read by other devices in the system to identify the host bridge, (e.g., Device ID, Vendor ID, Class Code, etc.).

Another part of the Auto-Configuration mechanism is to setup the Local bus interface with the host processor and, optionally, provide reset control to the host processor. The Local Bus Configuration register is loaded from the serial EEPROM image. This will set the protocol of the Local interface. The Host Control register is loaded by the Auto-Configuration mechanism and can control reset to the host processor. Utilization of the CY7C09449PV RSTOUTD output signal, (or its complement, RSTOUTD), is how the CY7C09449PV can control host processor reset. The Host Control register image is stored in the serial EEPROM and indicates if the reset will remain asserted or will release after Auto-Configuration is complete. Normally, it should release the host from reset. If it is not released, then an external PCI master will be required to release the host processor.

Finally, the CY7C09449PV uses the Direct Access function to configure PCI devices on the PCI bus. The first device that it configures is typically itself. It is important that the Master Enable bit is set. Without this bit asserted, the CY7C09449PV

cannot configuration itself (or any other devices) via the PCI bus.

Dual-Port Shared Memory

In order to perform concurrent target access to shared memory from the PCI and Local bus interfaces it is generally necessary to devise a handshake protocol and/or address access allocation scheme to prevent corrupting memory locations. That is, a location within the CY7C09449PV dual-port memory may be corrupted if a read from one interface occurs simultaneously with a write from the other interface to that same location. The CY7C09449PV assists the user in managing concurrent access to the shared memory.

The CY7C09449PV PCI and Local bus are high performance interfaces. Internal logic performs read pre-fetching in order to

maintain a full speed, zero wait-state, burst access to the shared memory. For managing memory access, the CY7C09449PV performs a disconnect or wait for target reads at each 64-byte boundary. If a user is allocating sections of memory to PCI and Local space and intends to execute simultaneous access to the shared memory from both interfaces, then this 64-byte boundary can be used to place PCI and Local sections of memory adjacent to each other. In other words, the CY7C09449PV has special logic that detects incoming burst addresses and will initiate the disconnect or wait at each 64-byte boundary. In this way, if the transaction is to end at the boundary, then no further pre-fetching occurs since time has been given to the master to end the bus transaction. For the PCI bus, this is performed by a target disconnect. For the Local bus, this is wait states.

Ordering Information

Ordering Code	Package Name	Package Type	Operating Range
CY7C09449PV-AC	TQFP160	160-Pin Plastic Thin Quad Flat Pack	0°C to +70°C

Package Diagram

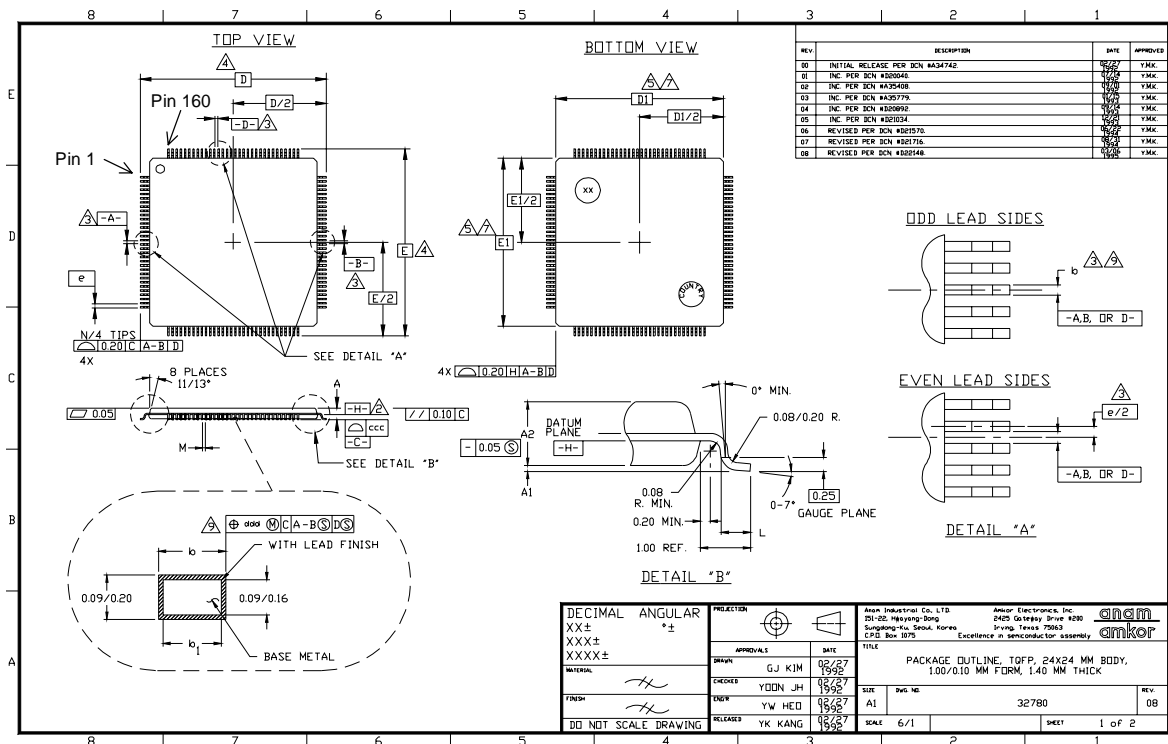

Package Diagram (continued)

NOTES:

1. ALL DIMENSIONING AND TOLERANCING CONFORM TO ANSI Y14.5-1982.
2. DATUM PLANE $\square\text{---}\square$ LOCATED AT MOLD PARTING LINE AND COINCIDENT WITH LEAD WHERE LEAD EXITS PLASTIC BODY AT BOTTOM OF PARTING LINE.
3. DATUMS $\square\text{---}\square$ AND $\square\text{---}\square$ TO BE DETERMINED AT CENTERLINE BETWEEN LEADS WHERE LEADS EXIT PLASTIC BODY AT DATUM PLANE $\square\text{---}\square$.
4. TO BE DETERMINED AT SEATING PLANE $\square\text{---}\square$.
5. DIMENSIONS D1 AND E1 DO NOT INCLUDE MOLD PROTRUSION. ALLOWABLE MOLD PROTRUSION IS 0.254 MM ON D1 AND E1 DIMENSIONS.
6. *N* IS THE TOTAL NUMBER OF TERMINALS.
7. THESE DIMENSIONS TO BE DETERMINED AT DATUM PLANE $\square\text{---}\square$.
8. PACKAGE TOP DIMENSIONS ARE SMALLER THAN BOTTOM DIMENSIONS AND TOP OF PACKAGE WILL NOT OVERHANG BOTTOM OF PACKAGE.
9. DIMENSION ϕ DOES NOT INCLUDE DAMBAR PROTRUSION. ALLOWABLE DAMBAR PROTRUSION SHALL BE 0.08mm TOTAL IN EXCESS OF THE ϕ DIMENSION AT MAXIMUM MATERIAL CONDITION. DAMBAR CANNOT BE LOCATED ON THE LOWER RADIUS OR THE FOOT.
10. CONTROLLING DIMENSION: MILLIMETER.
11. MAXIMUM ALLOWABLE DIE THICKNESS TO BE ASSEMBLED IN THIS PACKAGE FAMILY IS 0.38 MILLIMETERS.
12. THIS OUTLINE CONFORMS TO JEDEC PUBLICATION 95 REGISTRATION MO-136, VARIATION BV.

SYMBOL	JEDEC VARIATION ALL DIMENSIONS IN MILLIMETERS			NOTE
	BV			
	MIN.	NOM.	MAX.	
A	\approx	\approx	1.60	
A1	0.05	0.10	0.15	
A2	1.35	1.40	1.45	
D	26.00 BSC.			4
D1	24.00 BSC.			7,8
E	26.00 BSC.			4
E1	24.00 BSC.			7,8
L	0.45	0.60	0.75	
M	0.14	\approx	\approx	
N	*160, 176			
e	0.50 BSC.			
b	0.17	0.22	0.27	9
b1	0.17	0.20	0.23	
ccc	\approx	\approx	0.08	
ddd	\approx	\approx	0.08	

* NOTE: THE 160 LEAD IS A COMPLIANT DEPOPULATION OF THE 176 LEAD MO-136 VARIATION BV.

TITLE			
PACKAGE OUTLINE, TOP, 24x24 MM BODY, 1.00/0.10 MM FORM, 1.40 MM THICK			
SIZE	ENG NO	32780	REV
A1			08
SCALE	6/1		SHEET 2 OF 2

Document Title: CY7C09449PV-AC 128Kb Dual-Port SRAM with PCI Bus Controller (PCI-DP)				
Document Number: 38-06061				
REV.	ECN NO.	Issue Date	Orig. of Change	Description of Change
**	113168	02/14/02	DSG	Change from Spec number: 38-01014 to 38-05172 Change from Spec number: 38-05172 to 38-06061
*A	122309	12/27/02	RBI	Power up requirements added to Absolute Maximum Ratings Information